

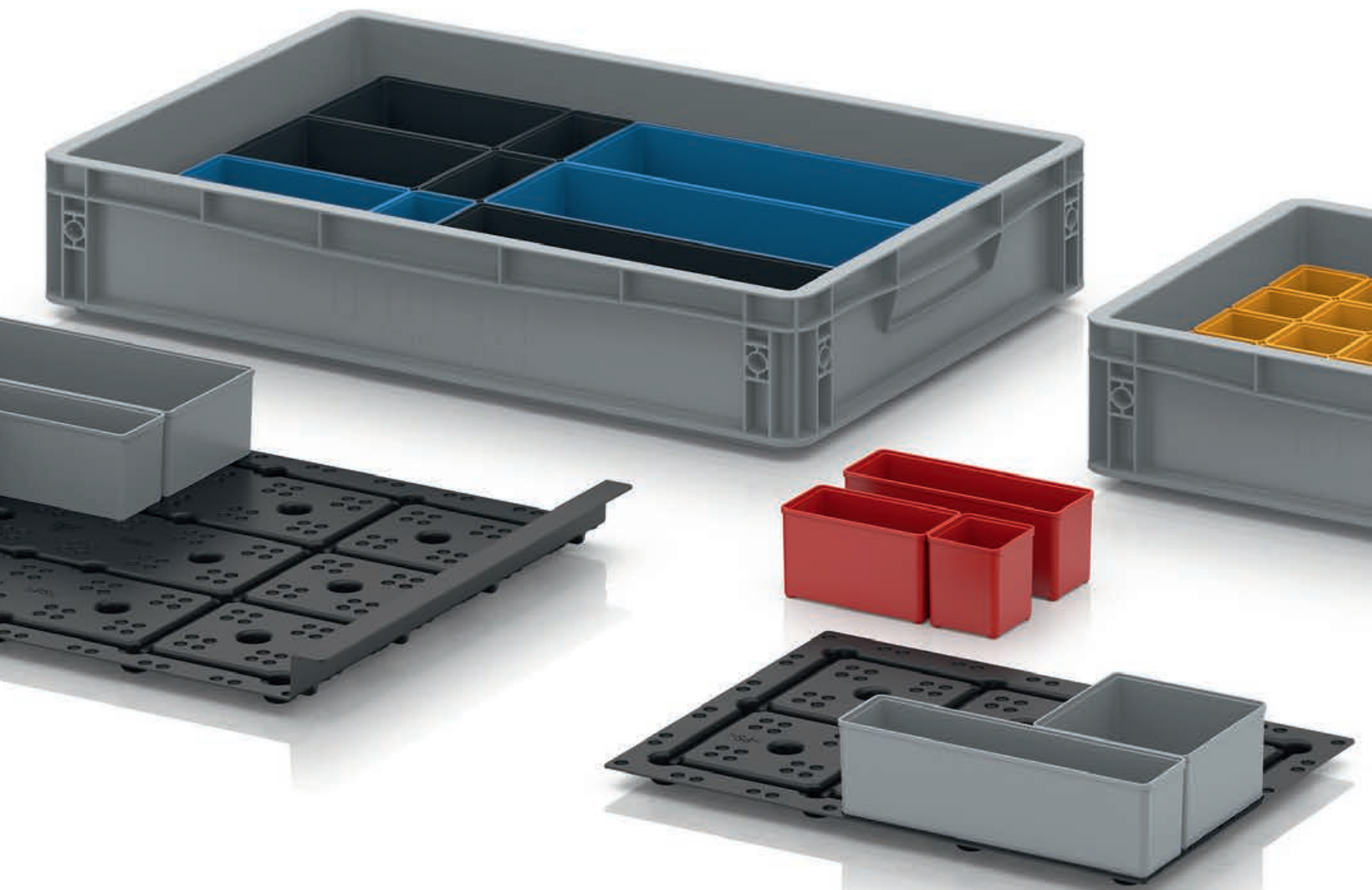

PACKAGING SOLUTIONS.

PRODUCT CATALOGUE 2023



First steps must be taken BRAVELY,
followed by AMBITION and enriched with LUCK

—
Robert Auer

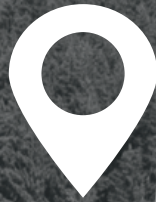

AMERANG

47° 59' 32.83" N 12° 18' 26.617" E

IN CONSTRUCTION:
Fully automated high-bay storage
system with 20,000 storing positions





THERE IS A PACKAGING SOLUTION.

AUER Packaging is a medium-sized company from the beautiful Bavarian alpine upland. AUER GmbH has developed itself over the last 30 years, through willpower and passion, into one of the leading German manufacturers of storage and transport products made from synthetics. The continuous advancement of storage and transport containers for solid and liquid materials is the central focus in day-to-day business at AUER Packaging: the 35 million products that we manufacture each year are all made in Germany. A growing number of these products are being made in our own production halls at our headquarters in Amerang. Reliability, modernity and flexibility are three words to describe the powerfully expanding company. Because the best service, the most up-to-date production and products suited to customer needs are self-evident at AUER Packaging. Service is therefore boldly underlined - whether it's an individual or bulk order, small business or large corporation.



FOR AN INNOVATED WORLD.

The Management team, consisting of Robert Auer, Diana Auer and Philipp Auer, has enjoyed three exciting and successful decades at the helm. We acquired the technology park in 2014. This transaction was complemented by the construction of two production halls. We then achieved the next two milestones in our company's history: We built a major warehouse facility and added a third production hall. A total of 38 state-of-the-art injection moulding machines in the three halls ensure flexible capacity at the Amerang site. A new fully automated logistics centre will also be brought on stream. Over the next few years, AUER Packaging will also continue to make a name for itself by launching new and innovative products on the market.



MUER
PACKAGING



8t

MUER
PACKAGING

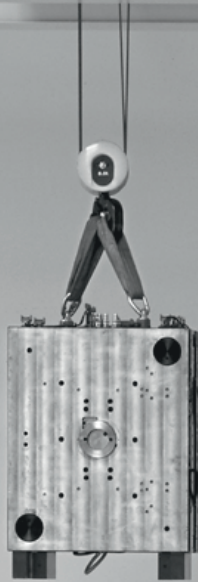

QUALITY
MADE IN GERMANY





QUALITY MADE IN GERMANY.

As an expert in industrial plastic packaging, AUER Packaging ensures that its products are always made from whatever material is best suited for the intended purpose: properties such as temperature stability, load capacity and impact resistance guarantee high-quality, robust products. What sets AUER Packaging apart is the fact that its products boast a unique, clean design, are extremely easy to use and feature well-crafted high-quality materials.

With the help of the QR code, you can gain valuable insights into our production operation.



www.auer-packaging.de/videos/company/AUER-Packaging-Produktionshalle.mp4

DIRECT SALES – YOUR ADVANTAGES.

AUER Packaging products are exceptional value for money. The strategy behind this is as simple as it is successful: all products are sold exclusively via direct sales channels – i.e. via the online store, via telephone or via email. All products which feature the “Ready for shipment in 24h” logo are dispatched within 24 hours of being ordered. Quality doesn’t always have to come at a cost – see for yourself!

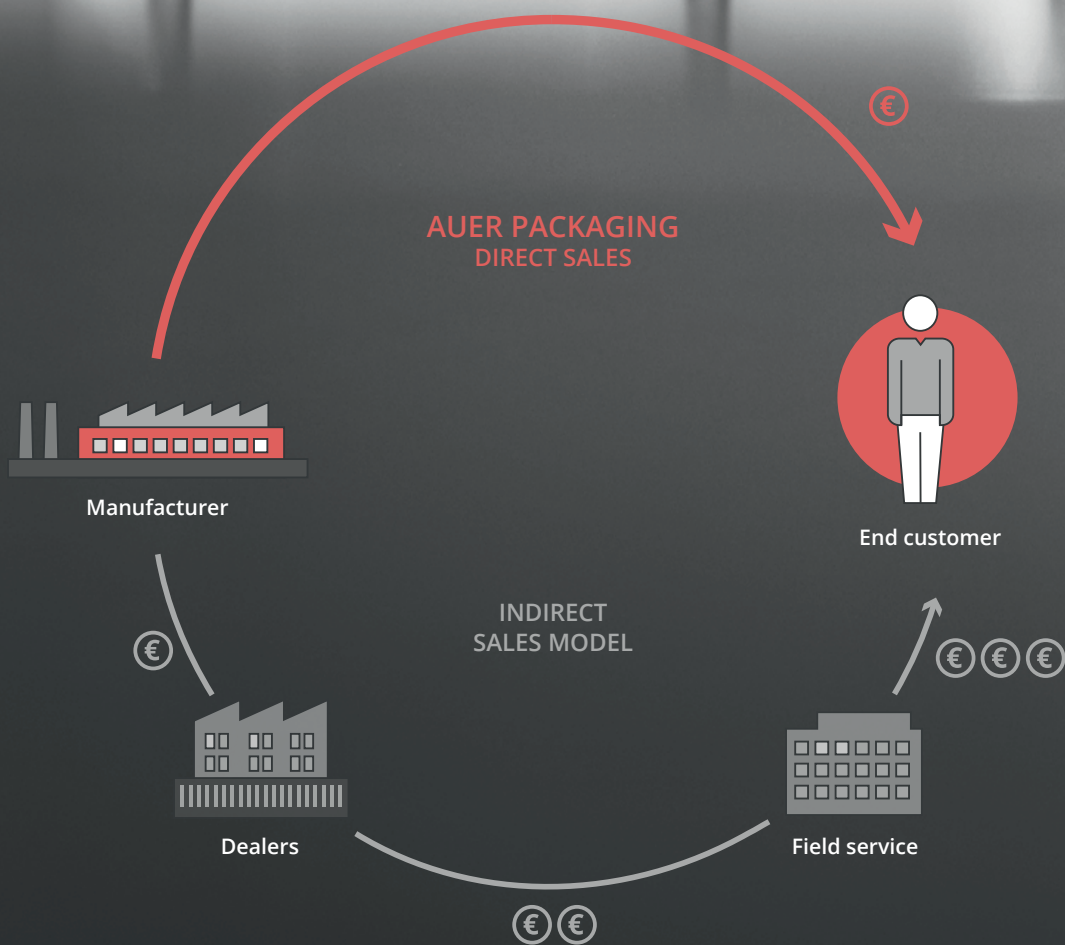





Sustainability through quality.

The idea that sustainability is only what you make of it also applies to plastic. AUER Packaging products are designed for long-term use. Our products have a typical service life of at least 15 years and many can be used for even longer. As early on as the development stage, we ensure that not a single gram too much and not a single gram too little is used. We strive to achieve the perfect balance between material consumption and functionality. Almost all AUER Packaging products are single-material solutions. This helps to ensure that they can be easily and, most importantly, fully recycled. At AUER Packaging, we also use in-house recycled material, for example for AUER plastic pallets.

All AUER Packaging processes are optimised in terms of energy and carbon efficiency: as such, we have managed to cut carbon emissions per kilo of granulate in half compared to 2019. We use only cutting-edge machinery in our production processes. The cooling circuit for production is designed to ensure that we do not have to add any fresh water or chemical additives. We use the waste heat to heat the company buildings. Our new photovoltaic system will produce up to 700,000 watts of power, which we will use for production purposes.

16



STACKABLE CONTAINERS

58



SYSTEM BOXES & CASES

96



SPACE-SAVING CONTAINERS

104



STORAGE BOXES WITH OPEN FRONT

118



PAILS & SCREW-TOP JARS

126

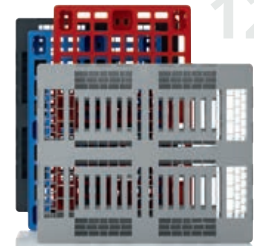

PLASTIC PALLETS

134



PALLET CONTAINERS

148



IBC CONTAINERS

156



TRANSPORTATION AIDS



SYSTEM TROLLEYS

166

198



ESD PRODUCTS

232



CUSTOMISATION

CONTENTS

STACKABLE CONTAINERS

Euro containers	18
Custom-sized containers	50
KLT boxes	54

SYSTEM BOXES & CASES

Assortment boxes	60
Tool boxes	74
Protective cases	90

SPACE-SAVING CONTAINERS

Reusable containers	98
Foldable boxes	102

STORAGE BOXES WITH OPEN FRONT

106

PAILS & SCREW-TOP JARS

Pails	120
Screw-top jars	124

PLASTIC PALLETS

128

PALLET CONTAINERS

Big boxes	136
Collapsible big boxes	138

IBC CONTAINERS

IBC containers Classic	150
Foldable IBC	151

TRANSPORTATION AIDS

Transport trolleys	158
Sack trucks	162
Wheels	164

SYSTEM TROLLEYS

for rack boxes	168
for tipping boxes	170
for Euro containers	172

ESD PRODUCTS

ESD Euro containers	200
ESD storage boxes with open front	202
ESD system trolleys	208
ESD foldable boxes	218
ESD KLT boxes	220
ESD pallets	224

CUSTOMISATION

Printing	233
Special colours	235



STACKABLE CONTAINERS

—
Our classics



EURO CONTAINERS SOLID

AVAILABLE UP FROM 1 PIECE
no minimum purchase order.

SPECIAL COLOURS
Simply order online

READY FOR DISPATCH **24** hours**



Sense of order

AUER Packaging's solid-walled Euro container is an impressive combination of inimitable, simple design and great stability. Its robustness and high quality materials make this Euro box particularly durable and consequently economical.

» Find ESD version on page 200

- Acid and alkali-resistant
- All commonly used Euro formats
- Cold and heat-resistant
- Suitable for conveyor systems

***) only for orders placed via the online shop. Dispatch only on working days, provided the goods are in stock. Information regarding availability and current dispatch times can be found in the online shop.

EURO CONTAINERS SOLID HANDLES FRONT CLOSED

RAL 7001

Outer dimensions L x W x H (cm)	Article No.	Price for single unit	Units on pallet	Unit price on pallet
20 x 15 x 12.0	EG 21512 HG	€2.17	760	€1.67
30 x 20 x 12.0	EG 32/12 HG	€3.46	380	€2.66
30 x 20 x 17.0	EG 32/17 HG	€3.93	260	€3.02
40 x 30 x 7.5	EG 43/75 HG	€4.35	330	€3.35
40 x 30 x 12.0	EG 43/12 HG	€5.14	190	€3.96
40 x 30 x 17.0	EG 43/17 HG	€6.11	130	€4.70
40 x 30 x 22.0	EG 43/22 HG	€7.29	140	€5.61
40 x 30 x 27.0	EG 43/27 HG	€7.89	80	€6.07
40 x 30 x 32.0	EG 43/32 HG	€8.92	70	€6.86
60 x 40 x 7.5	EG 64/75 HG	€6.65	165	€5.12
60 x 40 x 12.0	EG 64/12 HG	€7.87	95	€6.05
60 x 40 x 17.0	EG 64/17 HG	€9.10	65	€7.00
60 x 40 x 22.0	EG 64/22 HG	€10.33	50	€7.95
60 x 40 x 27.0	EG 64/27 HG	€12.27	40	€9.44
60 x 40 x 32.0	EG 64/32 HG	€13.52	45	€10.40
60 x 40 x 42.0	EG 64/42 HG	€16.93	25	€13.02
80 x 60 x 12.0	EG 86/12 HG	€19.36	34	€14.90
80 x 60 x 22.0	EG 86/22 HG	€24.81	20	€19.08
80 x 60 x 32.0	EG 86/32 HG	€28.31	12	€21.78
80 x 60 x 42.0	EG 86/42 HG	€34.66	14	€26.66
80 x 60 x 52.0	EG 86/52 HG	€43.48	12	€33.45



EURO CONTAINERS SOLID HANDLES FRONT OPEN

RAL 7001

Outer dimensions L x W x H (cm)	Article No.	Price for single unit	Units on pallet	Unit price on pallet
40 x 30 x 17.0	EG 43/17	€6.11	130	€4.70
40 x 30 x 22.0	EG 43/22	€7.29	140	€5.61
40 x 30 x 27.0	EG 43/27	€7.89	80	€6.07
40 x 30 x 32.0	EG 43/32	€8.92	70	€6.86
60 x 40 x 12.0	EG 64/12	€7.87	95	€6.05
60 x 40 x 17.0	EG 64/17	€9.10	65	€7.00
60 x 40 x 22.0	EG 64/22	€10.33	50	€7.95
60 x 40 x 27.0	EG 64/27	€12.27	40	€9.44
60 x 40 x 32.0	EG 64/32	€13.52	45	€10.40
60 x 40 x 42.0	EG 64/42	€16.93	25	€13.02
80 x 60 x 22.0	EG 86/22	€24.81	20	€19.08
80 x 60 x 32.0	EG 86/32	€28.31	12	€21.78
80 x 60 x 42.0	EG 86/42	€34.66	14	€26.66
80 x 60 x 52.0	EG 86/52	€43.48	12	€33.45



OUR TIP: SELECT HANDLE OPTIONS AS NEEDED

Closed handles, handles on the long sides, handles on the front or on all four sides: Every option is possible. Create your desired configuration online: www.auer-packaging.com

EURO CONTAINERS WITH HINGE LID

AVAILABLE UP FROM 1 PIECE
no minimum purchase order.

SPECIAL COLOURS
Simply order online

READY FOR DISPATCH **24** hours**



Securely closed

AUER Packaging's hinge-lid Euro container can be closed in next to no time thanks to its easy-to-use hinge system. This provides the best possible protection from damage in transit and contamination.

» Find ESD version on page 201

- Also stackable with lid
- Matched to Euro dimensions
- Sturdy hinges
- With open or closed hand grips

***) only for orders placed via the online shop. Dispatch only on working days, provided the goods are in stock. Information regarding availability and current dispatch times can be found in the online shop.

EURO CONTAINERS WITH HINGE LID HANDLES CLOSED

RAL 7001

Outer dimensions L x W x H (cm)	Article No.	Price for single unit	Units on pallet	Unit price on pallet
20 x 15 x 13.5	ED 21512 HG	€5.70	640	€4.38
30 x 20 x 13.5	ED 32/12 HG	€6.10	320	€4.69
30 x 20 x 18.5	ED 32/17 HG	€6.48	240	€4.98
40 x 30 x 9.0	ED 43/75 HG	€10.11	270	€7.77
40 x 30 x 13.5	ED 43/12 HG	€10.83	160	€8.33
40 x 30 x 18.5	ED 43/17 HG	€11.49	120	€8.84
40 x 30 x 23.5	ED 43/22 HG	€12.00	90	€9.23
40 x 30 x 28.5	ED 43/27 HG	€12.66	70	€9.74
40 x 30 x 33.5	ED 43/32 HG	€13.47	60	€10.36
60 x 40 x 9.0	ED 64/75 HG	€13.80	130	€10.62
60 x 40 x 13.5	ED 64/12 HG	€14.48	85	€11.14
60 x 40 x 18.5	ED 64/17 HG	€15.79	60	€12.15
60 x 40 x 23.5	ED 64/22 HG	€17.13	45	€13.18
60 x 40 x 28.5	ED 64/27 HG	€19.23	35	€14.79
60 x 40 x 33.5	ED 64/32 HG	€20.72	30	€15.94
60 x 40 x 43.5	ED 64/42 HG	€24.12	25	€18.55
80 x 60 x 13.5	ED 86/12 HG	€40.70	34	€31.31
80 x 60 x 23.5	ED 86/22 HG	€44.34	18	€34.11
80 x 60 x 33.5	ED 86/32 HG	€47.24	12	€36.34
80 x 60 x 43.5	ED 86/42 HG	€52.72	10	€40.55
80 x 60 x 54.0	ED 86/52 HG	€62.40	8	€48.00



EURO CONTAINERS WITH HINGE LID HANDLES OPEN

RAL 7001

Outer dimensions L x W x H (cm)	Article No.	Price for single unit	Units on pallet	Unit price on pallet
40 x 30 x 18.5	ED 43/17	€11.49	120	€8.84
40 x 30 x 23.5	ED 43/22	€12.00	90	€9.23
40 x 30 x 28.5	ED 43/27	€12.66	70	€9.74
40 x 30 x 33.5	ED 43/32	€13.47	60	€10.36
60 x 40 x 13.5	ED 64/12	€14.48	85	€11.14
60 x 40 x 18.5	ED 64/17	€15.79	60	€12.15
60 x 40 x 23.5	ED 64/22	€17.13	45	€13.18
60 x 40 x 28.5	ED 64/27	€19.23	35	€14.79
60 x 40 x 33.5	ED 64/32	€20.72	30	€15.94
60 x 40 x 43.5	ED 64/42	€24.12	25	€18.55
80 x 60 x 23.5	ED 86/22	€44.34	18	€34.11
80 x 60 x 33.5	ED 86/32	€47.24	12	€36.34
80 x 60 x 43.5	ED 86/42	€52.72	10	€40.55
80 x 60 x 54.0	ED 86/52	€62.40	8	€48.00



OUR TIP: CONTAINERS IN SPECIAL COLOURS

Are the standard colours of our products not compatible with your corporate colors image? No problem! We manufacture our products in any colour. In the shop, you can choose between predefined special colours. And if you cannot find what you are looking for, please do not hesitate to contact us!

You will find further information under: www.auer-packaging.com

EURO CONTAINER CASES

AVAILABLE UP FROM 1 PIECE
no minimum purchase order.

SPECIAL COLOURS
Simply order online



READY FOR DISPATCH within **24** hours **

All-rounder with handle

AUER Packaging's Euro container case has practical handles that enable the container to be carried safely and comfortably – even if the contents are heavy. To secure the contents, the lid can be locked with two hinges and two snap locks.

- Also stackable with lid
- Closed grab holes
- Several handle options
- Especially sturdy

EURO CONTAINER CASES 1 HANDLE ON THE LONG SIDE

RAL 7001

Outer dimensions L x W x H (cm)	Article No.	Price for single unit	Units on pallet	Unit price on pallet
30 x 20 x 13.5	ED 32/12 HG 1G	€20.66	320	€15.89
30 x 20 x 18.5	ED 32/17 HG 1G	€20.97	240	€16.13
40 x 30 x 9.0	ED 43/75 HG 1G	€24.95	270	€19.19
40 x 30 x 13.5	ED 43/12 HG 1G	€25.69	160	€19.76
40 x 30 x 18.5	ED 43/17 HG 1G	€26.35	120	€20.27
40 x 30 x 23.5	ED 43/22 HG 1G	€26.86	90	€20.66
40 x 30 x 28.5	ED 43/27 HG 1G	€27.52	70	€21.17
40 x 30 x 33.5	ED 43/32 HG 1G	€28.33	60	€21.79
60 x 40 x 9.0	ED 64/75 HG 1G	€28.66	130	€22.05
60 x 40 x 13.5	ED 64/12 HG 1G	€29.01	85	€22.31
60 x 40 x 18.5	ED 64/17 HG 1G	€29.52	60	€22.71
60 x 40 x 23.5	ED 64/22 HG 1G	€30.74	45	€23.65
60 x 40 x 28.5	ED 64/27 HG 1G	€32.84	35	€25.26
60 x 40 x 33.5	ED 64/32 HG 1G	€34.33	30	€26.41
60 x 40 x 43.5	ED 64/42 HG 1G	€37.73	25	€29.02
80 x 60 x 13.5	ED 86/12 HG 1G	€55.56	34	€42.74
80 x 60 x 23.5	ED 86/22 HG 1G	€59.20	18	€45.54
80 x 60 x 33.5	ED 86/32 HG 1G	€62.09	12	€47.76
80 x 60 x 43.5	ED 86/42 HG 1G	€66.33	10	€51.02
80 x 60 x 54.0	ED 86/52 HG 1G	€76.01	8	€58.47



***) only for orders placed via the online shop. Dispatch only on working days, provided the goods are in stock. Information regarding availability and current dispatch times can be found in the online shop.

EURO CONTAINER CASES 2 HANDLES ON THE FRONT SIDE

RAL 7001



Outer dimensions L x W x H (cm)	Article No.	Price for single unit	Units on pallet	Unit price on pallet
40 x 30 x 9.0	ED 43/75 HG 2G	€39.81	270	€30.62
40 x 30 x 13.5	ED 43/12 HG 2G	€40.55	160	€31.19
40 x 30 x 18.5	ED 43/17 HG 2G	€41.21	120	€31.70
40 x 30 x 23.5	ED 43/22 HG 2G	€41.72	90	€32.09
40 x 30 x 28.5	ED 43/27 HG 2G	€42.38	70	€32.60
40 x 30 x 33.5	ED 43/32 HG 2G	€43.19	60	€33.22
60 x 40 x 9.0	ED 64/75 HG 2G	€43.52	130	€33.47
60 x 40 x 13.5	ED 64/12 HG 2G	€43.87	85	€33.74
60 x 40 x 18.5	ED 64/17 HG 2G	€44.38	60	€34.14
60 x 40 x 23.5	ED 64/22 HG 2G	€44.96	45	€34.58
60 x 40 x 28.5	ED 64/27 HG 2G	€46.45	35	€35.73
60 x 40 x 33.5	ED 64/32 HG 2G	€47.94	30	€36.88
60 x 40 x 43.5	ED 64/42 HG 2G	€51.34	25	€39.49
80 x 60 x 13.5	ED 86/12 HG 2G	€70.42	34	€54.17
80 x 60 x 23.5	ED 86/22 HG 2G	€74.06	18	€56.97
80 x 60 x 33.5	ED 86/32 HG 2G	€76.95	12	€59.19
80 x 60 x 43.5	ED 86/42 HG 2G	€80.39	10	€61.84
80 x 60 x 54.0	ED 86/52 HG 2G	€89.63	8	€68.94



1 HANDLE ON THE LONG SIDE, 2 HANDLES ON THE FRONT SIDE

RAL 7001



Outer dimensions L x W x H (cm)	Article No.	Price for single unit	Units on pallet	Unit price on pallet
40 x 30 x 9.0	ED 43/75 HG 3G	€54.64	270	€42.03
40 x 30 x 13.5	ED 43/12 HG 3G	€55.34	160	€42.57
40 x 30 x 18.5	ED 43/17 HG 3G	€55.98	120	€43.06
40 x 30 x 23.5	ED 43/22 HG 3G	€56.46	90	€43.43
40 x 30 x 28.5	ED 43/27 HG 3G	€57.09	70	€43.92
40 x 30 x 33.5	ED 43/32 HG 3G	€57.88	60	€44.52
60 x 40 x 9.0	ED 64/75 HG 3G	€58.30	130	€44.84
60 x 40 x 13.5	ED 64/12 HG 3G	€58.59	85	€45.07
60 x 40 x 18.5	ED 64/17 HG 3G	€59.07	60	€45.44
60 x 40 x 23.5	ED 64/22 HG 3G	€59.59	45	€45.84
60 x 40 x 28.5	ED 64/27 HG 3G	€60.06	35	€46.20
60 x 40 x 33.5	ED 64/32 HG 3G	€61.55	30	€47.35
60 x 40 x 43.5	ED 64/42 HG 3G	€64.95	25	€49.96
80 x 60 x 13.5	ED 86/12 HG 3G	€84.98	34	€65.37
80 x 60 x 23.5	ED 86/22 HG 3G	€88.36	18	€67.97
80 x 60 x 33.5	ED 86/32 HG 3G	€90.98	12	€69.99
80 x 60 x 43.5	ED 86/42 HG 3G	€94.26	10	€72.51
80 x 60 x 54.0	ED 86/52 HG 3G	€103.24	8	€79.41



2 HANDLES ON THE LONG SIDE

RAL 7001



Outer dimensions L x W x H (cm)	Article No.	Price for single unit	Units on pallet	Unit price on pallet
40 x 30 x 13.5	ED 43/12 HG 2GL	€40.48	160	€31.14
40 x 30 x 18.5	ED 43/17 HG 2GL	€41.12	120	€31.63
40 x 30 x 33.5	ED 43/32 HG 2GL	€43.02	60	€33.09
60 x 40 x 33.5	ED 64/32 HG 2GL	€47.94	30	€36.88
60 x 40 x 43.5	ED 64/42 HG 2GL	€51.34	25	€39.49
80 x 60 x 33.5	ED 86/32 HG 2GL	€76.13	12	€58.56
80 x 60 x 43.5	ED 86/42 HG 2GL	€79.94	10	€61.49
80 x 60 x 54.0	ED 86/52 HG 2GL	€89.63	8	€68.94

» More sizes can be found in our online shop.



EURO CONTAINERS WITH PRO HINGED LID WITHOUT LOCK



READY FOR DISPATCH within **24** hours **

AVAILABLE UP FROM 1 PIECE
no minimum purchase order.

Tight Euro containers

Our Euro containers also come with the Pro hinged lid, a feature that helps to prevent dust and splash water from seeping into the closed containers. It includes an integrated rubber seal that works with a clamping lever to provide the best-possible protection from most outside influences.

- Integrated rubber seal
- Dependable clamping lever
- Stackable with hinged lid

EURO CONTAINERS WITH PRO OG HINGED LID HANDLES CLOSED

RAL 7001

Outer dimensions L x W x H (cm)	Article No.	Price for single unit	Units on pallet	Unit price on pallet
40 x 30 x 13.5	EDP 43/12 HG	€49.45	160	€38.04
40 x 30 x 18.5	EDP 43/17 HG	€50.48	120	€38.83
40 x 30 x 23.5	EDP 43/22 HG	€51.26	90	€39.43
40 x 30 x 28.5	EDP 43/27 HG	€52.40	70	€40.31
40 x 30 x 33.5	EDP 43/32 HG	€53.51	60	€41.16
60 x 40 x 13.5	EDP 64/12 HG	€57.79	85	€44.45
60 x 40 x 18.5	EDP 64/17 HG	€59.10	60	€45.46
60 x 40 x 23.5	EDP 64/22 HG	€60.44	45	€46.49
60 x 40 x 28.5	EDP 64/27 HG	€62.54	35	€48.10
60 x 40 x 33.5	EDP 64/32 HG	€64.02	30	€49.25
60 x 40 x 43.5	EDP 64/42 HG	€67.43	25	€51.87



***) only for orders placed via the online shop. Dispatch only on working days, provided the goods are in stock. Information regarding availability and current dispatch times can be found in the online shop.

EURO CONTAINERS WITH PRO 1G HINGED LID

HANDLES CLOSED, 1 HANDLE ON THE LONG SIDE

RAL 7001



Outer dimensions L x W x H (cm)	Article No.	Price for single unit	Units on pallet	Unit price on pallet
40 x 30 x 13.5	EDP 43/12 HG 1G	€52.67	160	€40.51
40 x 30 x 18.5	EDP 43/17 HG 1G	€53.69	120	€41.30
40 x 30 x 23.5	EDP 43/22 HG 1G	€54.48	90	€41.90
40 x 30 x 28.5	EDP 43/27 HG 1G	€55.61	70	€42.78
40 x 30 x 33.5	EDP 43/32 HG 1G	€56.72	60	€43.63
60 x 40 x 13.5	EDP 64/12 HG 1G	€61.00	85	€46.92
60 x 40 x 18.5	EDP 64/17 HG 1G	€62.31	60	€47.93
60 x 40 x 23.5	EDP 64/22 HG 1G	€63.65	45	€48.96
60 x 40 x 28.5	EDP 64/27 HG 1G	€65.75	35	€50.58
60 x 40 x 33.5	EDP 64/32 HG 1G	€67.24	30	€51.72
60 x 40 x 43.5	EDP 64/42 HG 1G	€70.64	25	€54.34



EURO CONTAINERS WITH PRO 2GS HINGED LID

HANDLES CLOSED, 2 HANDLES ON THE FRONT SIDE

RAL 7001



Outer dimensions L x W x H (cm)	Article No.	Price for single unit	Units on pallet	Unit price on pallet
40 x 30 x 13.5	EDP 43/12 HG 2G	€76.68	160	€58.98
40 x 30 x 18.5	EDP 43/17 HG 2G	€77.70	120	€59.77
40 x 30 x 23.5	EDP 43/22 HG 2G	€78.49	90	€60.38
40 x 30 x 28.5	EDP 43/27 HG 2G	€79.62	70	€61.25
40 x 30 x 33.5	EDP 43/32 HG 2G	€80.73	60	€62.10
60 x 40 x 13.5	EDP 64/12 HG 2G	€85.01	85	€65.39
60 x 40 x 18.5	EDP 64/17 HG 2G	€86.32	60	€66.40
60 x 40 x 23.5	EDP 64/22 HG 2G	€87.66	45	€67.43
60 x 40 x 28.5	EDP 64/27 HG 2G	€89.76	35	€69.05
60 x 40 x 33.5	EDP 64/32 HG 2G	€91.25	30	€70.19
60 x 40 x 43.5	EDP 64/42 HG 2G	€94.65	25	€72.81



OUR TIP: MODEL WITH OPEN HANDLES

Euro containers equipped with the Pro hinged lid can be ordered with open handles as an option. You will find all models online: www.auer-packaging.com

EURO CONTAINERS WITH PRO HINGED LID WITH LOCK



READY FOR DISPATCH **24** hours**
within

AVAILABLE UP FROM 1 PIECE
no minimum purchase order.

Tightly sealed

Our Euro containers also come with the Pro hinged lid, a feature that helps to prevent dust and splash water from seeping into the closed containers. High-quality locks are integrated into the fastening devices used in the hinged lid. These locks prevent unauthorised individuals from gaining access to the containers' content.

- Integrated rubber seal
- Dependable clamping lever
- Stackable with hinged lid

EURO CONTAINERS WITH PRO OG HINGED LID HANDLES CLOSED

RAL 7001

Outer dimensions L x W x H (cm)	Article No.	Price for single unit	Units on pallet	Unit price on pallet
40 x 30 x 13.5	EDP S 43/12 HG	€55.36	160	€42.59
40 x 30 x 18.5	EDP S 43/17 HG	€56.39	120	€43.37
40 x 30 x 23.5	EDP S 43/22 HG	€57.72	90	€44.40
40 x 30 x 28.5	EDP S 43/27 HG	€58.31	70	€44.85
40 x 30 x 33.5	EDP S 43/32 HG	€59.42	60	€45.71
60 x 40 x 13.5	EDP S 64/12 HG	€63.69	85	€49.00
60 x 40 x 18.5	EDP S 64/17 HG	€65.01	60	€50.01
60 x 40 x 23.5	EDP S 64/22 HG	€66.34	45	€51.03
60 x 40 x 28.5	EDP S 64/27 HG	€68.44	35	€52.65
60 x 40 x 33.5	EDP S 64/32 HG	€69.93	30	€53.79
60 x 40 x 43.5	EDP S 64/42 HG	€73.33	25	€56.41



***) only for orders placed via the online shop. Dispatch only on working days, provided the goods are in stock.
Information regarding availability and current dispatch times can be found in the online shop.

EURO CONTAINERS WITH PRO 1G HINGED LID

HANDLES CLOSED, 1 HANDLE ON THE LONG SIDE

RAL 7001



Outer dimensions L x W x H (cm)	Article No.	Price for single unit	Units on pallet	Unit price on pallet
40 x 30 x 13.5	EDP S 43/12 HG 1G	€58.57	160	€45.06
40 x 30 x 18.5	EDP S 43/17 HG 1G	€59.60	120	€45.85
40 x 30 x 23.5	EDP S 43/22 HG 1G	€60.93	90	€46.87
40 x 30 x 28.5	EDP S 43/27 HG 1G	€61.52	70	€47.32
40 x 30 x 33.5	EDP S 43/32 HG 1G	€62.63	60	€48.18
60 x 40 x 13.5	EDP S 64/12 HG 1G	€66.91	85	€51.47
60 x 40 x 18.5	EDP S 64/17 HG 1G	€68.22	60	€52.48
60 x 40 x 23.5	EDP S 64/22 HG 1G	€69.56	45	€53.51
60 x 40 x 28.5	EDP S 64/27 HG 1G	€71.66	35	€55.12
60 x 40 x 33.5	EDP S 64/32 HG 1G	€73.14	30	€56.27
60 x 40 x 43.5	EDP S 64/42 HG 1G	€76.55	25	€58.88



EURO CONTAINERS WITH PRO 2GS HINGED LID

HANDLES CLOSED, 2 HANDLES ON THE FRONT SIDE

RAL 7001



Outer dimensions L x W x H (cm)	Article No.	Price for single unit	Units on pallet	Unit price on pallet
40 x 30 x 13.5	EDP S 43/12 HG 2G	€82.59	160	€63.53
40 x 30 x 18.5	EDP S 43/17 HG 2G	€83.61	120	€64.32
40 x 30 x 23.5	EDP S 43/22 HG 2G	€84.94	90	€65.34
40 x 30 x 28.5	EDP S 43/27 HG 2G	€85.53	70	€65.79
40 x 30 x 33.5	EDP S 43/32 HG 2G	€86.64	60	€66.65
60 x 40 x 13.5	EDP S 64/12 HG 2G	€90.92	85	€69.94
60 x 40 x 18.5	EDP S 64/17 HG 2G	€92.23	60	€70.95
60 x 40 x 23.5	EDP S 64/22 HG 2G	€93.57	45	€71.98
60 x 40 x 28.5	EDP S 64/27 HG 2G	€95.67	35	€73.59
60 x 40 x 33.5	EDP S 64/32 HG 2G	€97.16	30	€74.74
60 x 40 x 43.5	EDP S 64/42 HG 2G	€100.56	25	€77.35



OUR TIP: INDIVIDUAL PRINTING

You can make your AUER products a perfect match for your company image through individualised printing. Text or logo, monochrome or four-colour – configure our products to have the exact look you want. It's easy – simply use our online configurator or ask our customer support department to advise you.

You will find further information under: www.auer-packaging.com

SOLID EURO CONTAINERS WITH A COUPLING SYSTEM

READY FOR DISPATCH **24** hours**
within

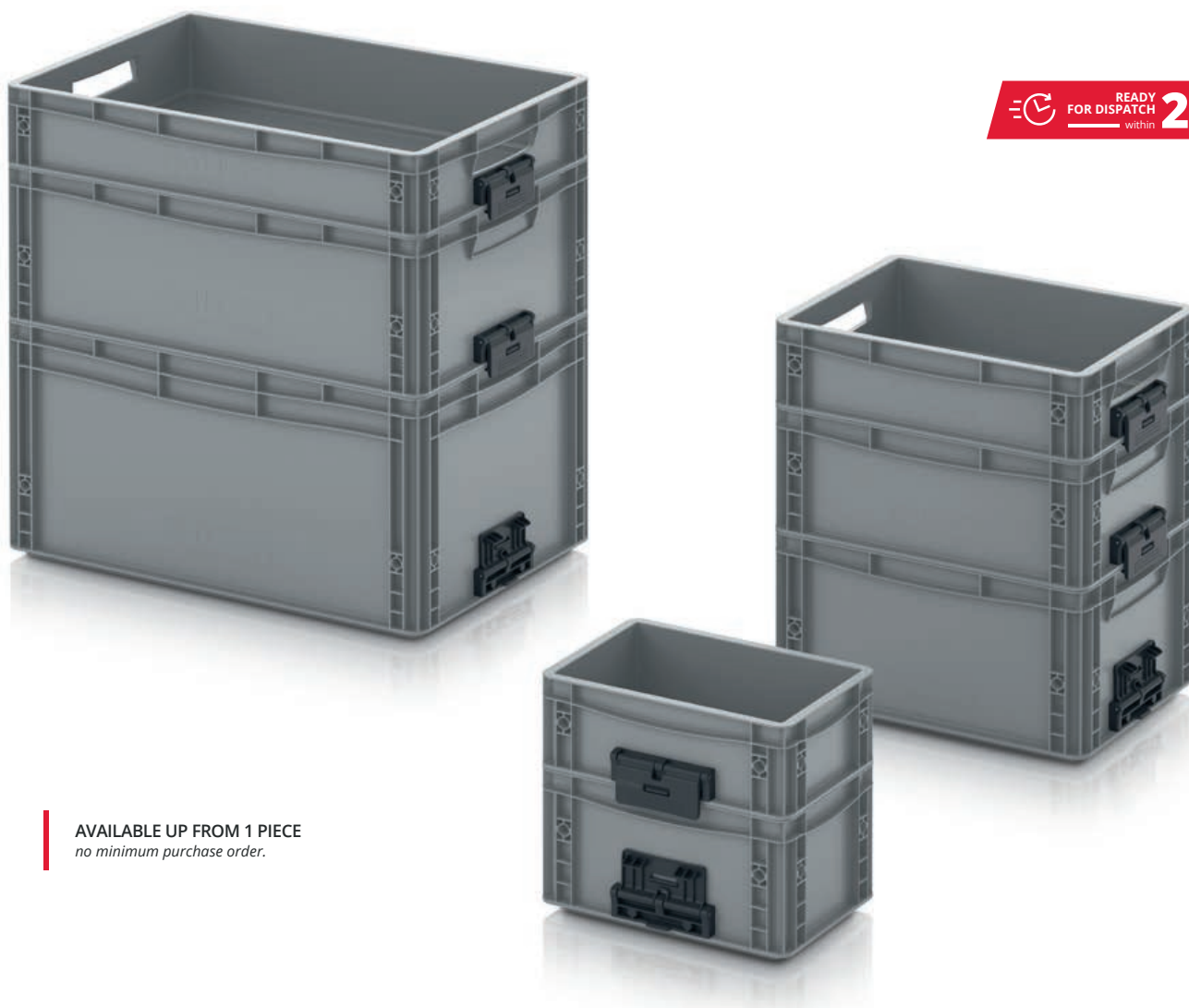

AVAILABLE UP FROM 1 PIECE
no minimum purchase order.

Tight fit

The coupling system is used for those times when Euro containers have to be firmly connected to one another and not stacked. Locked and opened with a flick of the wrist, a stack of Euro containers can be turned into a compact tower that is handled like one single container.

- Strong, dependable connection
- Fast and easy locking and unlocking
- Improved stack handling

***) only for orders placed via the online shop. Dispatch only on working days, provided the goods are in stock. Information regarding availability and current dispatch times can be found in the online shop.

SOLID EURO CONTAINERS WITH A COUPLING SYSTEM

HANDLES OPEN

RAL 7001

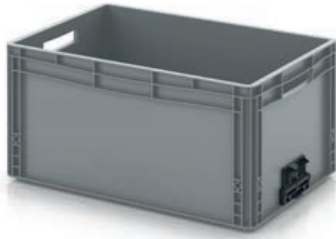

Outer dimensions L x W x H (cm)	Article No.	Price for single unit	Units per pallet	Unit price on pallet
30 x 20 x 12	EG V 32/12	€12.25	380	€9.42
30 x 20 x 17	EG V 32/17	€12.75	260	€9.81
40 x 30 x 12	EG V 43/12	€9.65	190	€7.42
40 x 30 x 17	EG V 43/17	€10.68	130	€8.21
40 x 30 x 22	EG V 43/22	€11.94	140	€9.18
40 x 30 x 27	EG V 43/27	€12.57	80	€9.67
40 x 30 x 32	EG V 43/32	€13.67	70	€10.52
60 x 40 x 12	EG V 64/12	€12.55	95	€9.65
60 x 40 x 17	EG V 64/17	€13.86	65	€10.66
60 x 40 x 22	EG V 64/22	€15.18	50	€11.68
60 x 40 x 27	EG V 64/27	€17.25	40	€13.27
60 x 40 x 32	EG V 64/32	€18.58	45	€14.29
60 x 40 x 42	EG V 64/42	€22.22	25	€17.09



SOLID EURO CONTAINERS WITH A COUPLING SYSTEM

HANDLES CLOSED

RAL 7001

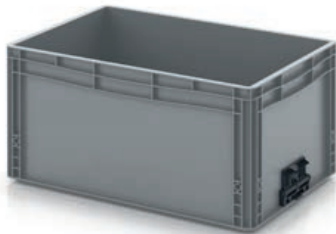

Outer dimensions L x W x H (cm)	Article No.	Price for single unit	Units per pallet	Unit price on pallet
30 x 20 x 12	EG V 32/12 HG	€7.85	380	€6.04
30 x 20 x 17	EG V 32/17 HG	€8.35	260	€6.42
40 x 30 x 12	EG V 43/12 HG	€9.65	190	€7.42
40 x 30 x 17	EG V 43/17 HG	€10.68	130	€8.21
40 x 30 x 22	EG V 43/22 HG	€11.94	140	€9.18
40 x 30 x 27	EG V 43/27 HG	€12.57	80	€9.67
40 x 30 x 32	EG V 43/32 HG	€13.67	70	€10.52
60 x 40 x 12	EG V 64/12 HG	€12.55	95	€9.65
60 x 40 x 17	EG V 64/17 HG	€13.86	65	€10.66
60 x 40 x 22	EG V 64/22 HG	€15.18	50	€11.68
60 x 40 x 27	EG V 64/27 HG	€17.25	40	€13.27
60 x 40 x 32	EG V 64/32 HG	€18.58	45	€14.29
60 x 40 x 42	EG V 64/42 HG	€22.22	25	€17.09



OUR TIP: CLOSE THE HANDLES YOURSELF

Do you want to skilfully cover open handles at a later time, or do you want to be flexible enough for any potential use? You will find handle covers for Euro containers on page 46 »

EURO CONTAINERS PERFORATED

AVAILABLE UP FROM 1 PIECE
no minimum purchase order.

SPECIAL COLOURS
Simply order online

READY FOR DISPATCH **24** hours**
within



Keeping you more in the picture

The design of AUER Packaging's perforated Euro container provides outstanding air and liquid permeability. No matter whether contents have to dry quickly or remain consistently moist – this container can handle the job!

- Hygienically flawless and easy to clean
- Suitable for dishwashers
- Stackable
- Optimal air circulation

EURO CONTAINERS PERFORATED

RAL 7001

Outer dimensions L x W x H (cm)	Article No.	Price for single unit	Units on pallet	Unit price on pallet
60 x 40 x 7.5	EO 64/75	€6.55	165	€5.04
60 x 40 x 12.0	EO 64/12	€7.33	95	€5.64
60 x 40 x 15.0	EO 64/15	€7.60	75	€5.84
60 x 40 x 17.0	EO 64/17	€8.05	65	€6.19
60 x 40 x 22.0	EO 64/22	€9.13	50	€7.03
60 x 40 x 27.0	EO 64/27	€10.21	40	€7.85
60 x 40 x 32.0	EO 64/32	€11.11	45	€8.55
60 x 40 x 42.0	EO 64/42	€13.13	25	€10.10



***) only for orders placed via the online shop. Dispatch only on working days, provided the goods are in stock.
Information regarding availability and current dispatch times can be found in the online shop.

MEAT CRATES

AVAILABLE UP FROM 1 PIECE
no minimum purchase order.

SPECIAL COLOURS
Simply order online



READY FOR DISPATCH within **24 hours** **

Hygienic meat storage

AUER Packaging's meat crate has been specially developed for use in the meat industry and fulfils the stringent requirements of the EHI Retail Institute. The E2 Euro crate drains water from its edge and consequently provides ideal conditions for storing and transporting meat products.

- For automated logistics
- Smooth inner surface for easy cleaning
- Suitable for dishwashers
- DIN 55423-compliant

MEAT CRATES

RAL 3020

Outer dimensions L x W x H (cm)	Article No.	Price for single unit	Units on pallet	Unit price on pallet
60 x 40 x 20	E2	€10.32	55	€7.93



***) only for orders placed via the online shop. Dispatch only on working days, provided the goods are in stock. Information regarding availability and current dispatch times can be found in the online shop.

ACCESSORIES

for Euro containers

Page 47 | Foldable handle

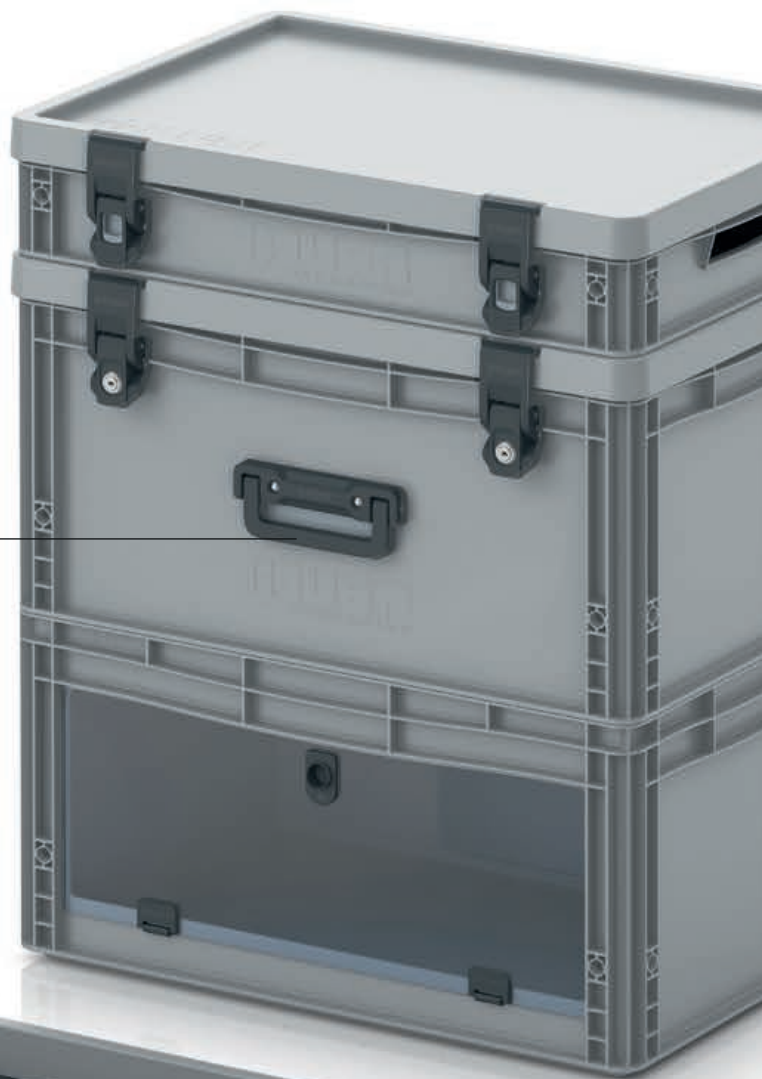

Page 40 | Insertable bin inserts for Euro containers

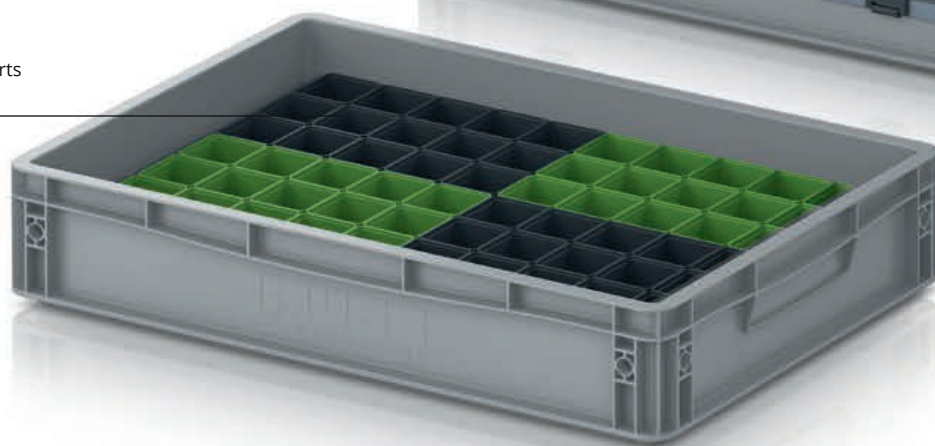

Page 42 | Partions for Euro containers

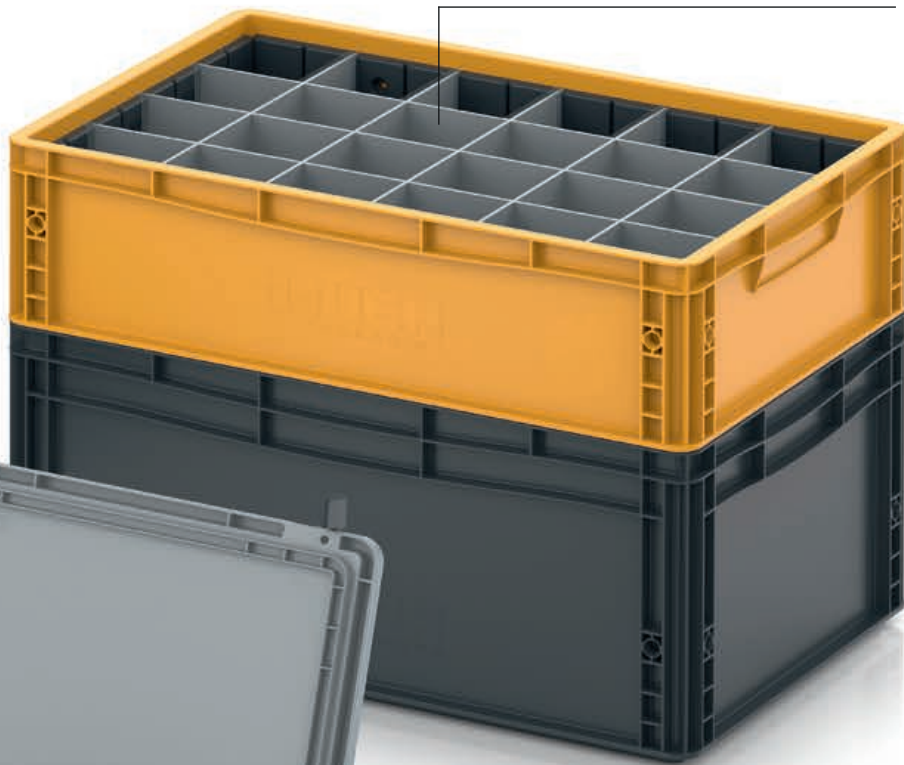

Page 34 | Insertable bins



INSERTABLE BINS FOR EURO CONTAINERS

AVAILABLE UP FROM 1 PIECE
no minimum purchase order.

READY FOR DISPATCH **24** hours**
within

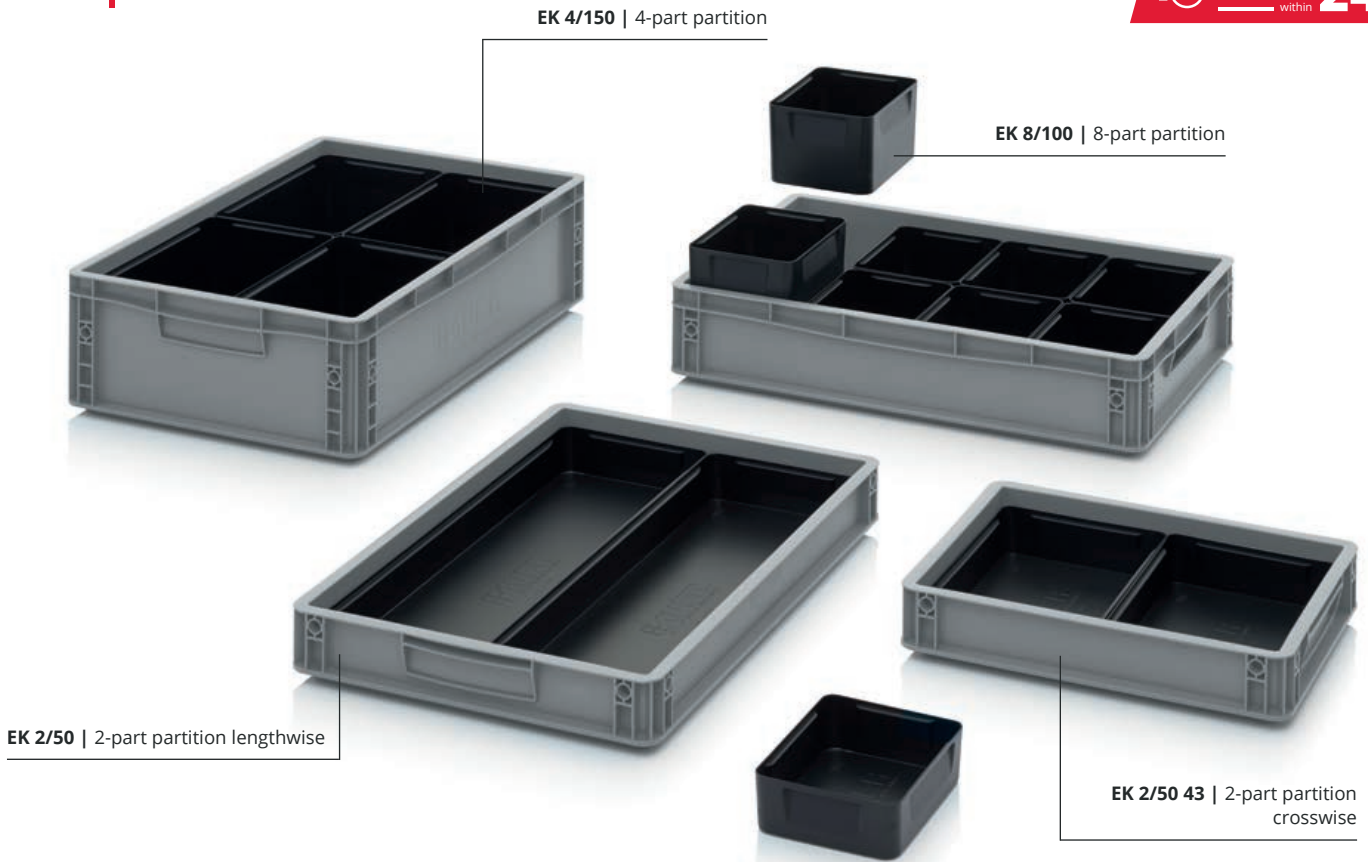

A perfect overview

AUER Packaging's insertable bin is the ideal solution for flexibly subdividing Euro containers. It can first be filled and pre-picked with varying loads of initial parts and then be combined with other insertable bins in the Euro container. A Euro container with basic dimensions of 60x40 cm can hold up to eight insertable bins.

- Grip rim for easy handling
- Stackable due to reinforced rim
- Variety of possible loading options
- Up to 8 insertable bins per container



INSERTABLE BINS FOR 40 x 30 cm EURO CONTAINERS

RAL 9017

	Outer dimensions L x W x H (cm)	Height (cm)	Article No.	Division	Price for single unit	Units on pallet	Unit price on pallet
1	26.6 x 18.4 x 5	5	EK 2/50 43	2-part partition cross	€2.67	1012	€2.05
2	26.6 x 18.4 x 10	10	EK 2/100 43	2-part partition cross	€3.11	440	€2.39
3	26.6 x 18.4 x 15	15	EK 2/150 43	2-part partition cross	€4.02	300	€3.10

» Find ESD version on page 226

***) only for orders placed via the online shop. Dispatch only on working days, provided the goods are in stock. Information regarding availability and current dispatch times can be found in the online shop.



INSERTABLE BINS FOR 60 x 40 cm EURO CONTAINERS

RAL 9017

	Outer dimensions L x W x H (cm)	Height (cm)	Article No.	Division	Price for single unit	Units on pallet	Unit price on pallet
4	56 x 18.3 x 5	5	EK 2/50	2-part partition length	€3.16	440	€2.43
5	56 x 18.3 x 10	10	EK 2/100	2-part partition length	€4.28	220	€3.29
6	56 x 18.3 x 15	15	EK 2/150	2-part partition length	€4.93	150	€3.79
7	28.2 x 18.3 x 5	5	EK 4/50	4th division	€2.43	968	€1.87
8	28.2 x 18.3 x 10	10	EK 4/100	4th division	€3.09	440	€2.37
9	28.2 x 18.3 x 15	15	EK 4/150	4th division	€3.73	300	€2.87
10	18.3 x 14.1 x 5	5	EK 8/50	8th division	€2.19	1800	€1.69
11	18.3 x 14.1 x 10	10	EK 8/100	8th division	€2.25	880	€1.73
12	18.3 x 14.1 x 15	15	EK 8/150	8th division	€2.70	630	€2.08

» Find ESD version on page 227



OUR TIP: STACK INSERT BOXES

Our insert boxes are stackable, providing an overview and order in the Euro container. Insert boxes can be combined flexibly in different heights.

Our customer service will gladly assist you: info@auer-packaging.com

INSERT BOXES INSERT EURO CONTAINERS 40 x 30 cm

AVAILABLE UP FROM 1 PIECE
no minimum purchase order.

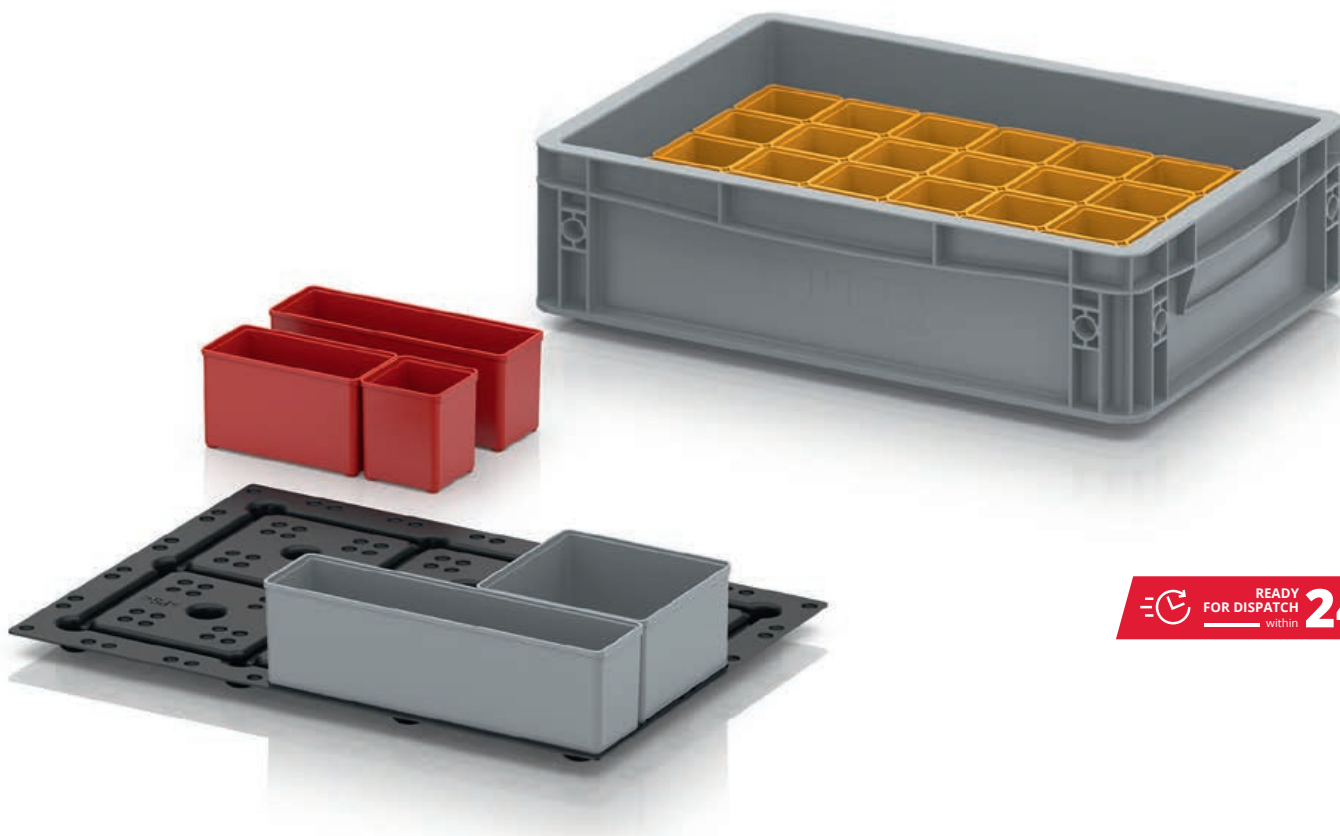

READY FOR DISPATCH within **24** hours **

Fixed positioning

The insertable bin insert allows the spacing created by using insertable bins in Euro containers to be balanced precisely. The insert has recesses in which the insertable bins snap into place according to the building block principle.

- For Euro container basic dimensions of 40 x 30 and 60 x 40 cm
- Insertable bins are perfectly secured in Euro containers
- Anti-slip positioning even when not fully packed
- Low dead weight

INSERTABLE BIN INSERTS FOR EURO CONTAINERS 40 x 30 cm

Article No.	Grid	Loading	Unit price
EG TEK 43	7x5	unloaded	€3.39

» You can find insertable bins on page 70

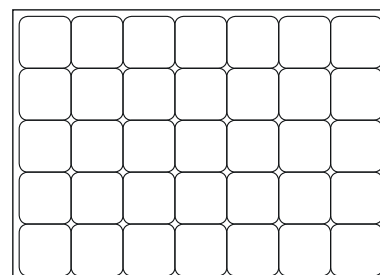

***) only for orders placed via the online shop. Dispatch only on working days, provided the goods are in stock. Information regarding availability and current dispatch times can be found in the online shop.

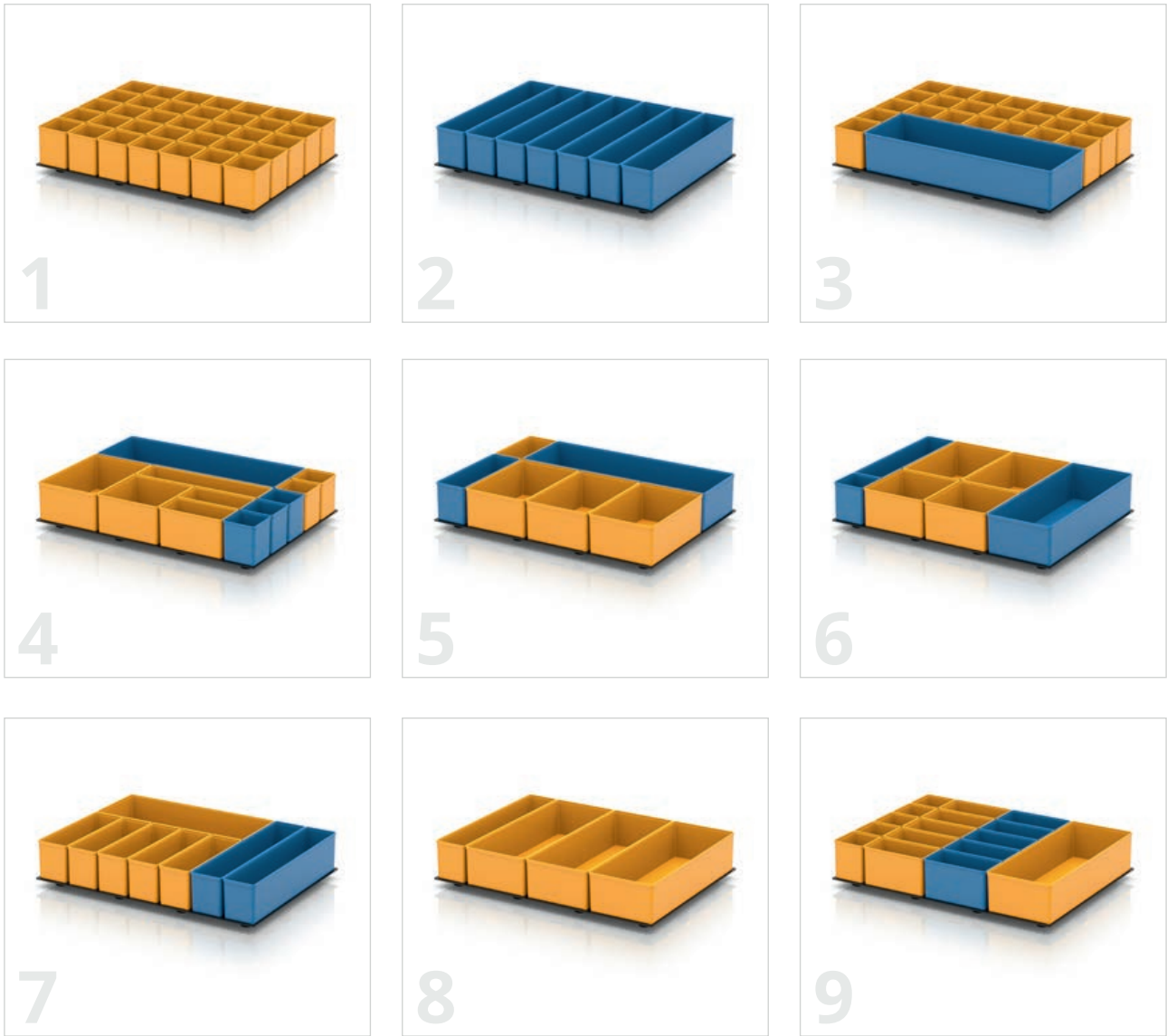

INSERTABLE BIN INSERTS FOR EURO CONTAINERS 40 × 30 cm

Article No.	Grid	Loading	Unit price	
1	EG TEK 43 B1	7x5	Assembly 1	€18.50
2	EG TEK 43 B2	7x5	Assembly 2	€12.78
3	EG TEK 43 B3	7x5	Assembly 3	€15.52
4	EG TEK 43 B4	7x5	Assembly 4	€12.29
5	EG TEK 43 B5	7x5	Assembly 5	€10.82
6	EG TEK 43 B6	7x5	Assembly 6	€11.15
7	EG TEK 43 B7	7x5	Assembly 7	€12.21
8	EG TEK 43 B8	7x5	Assembly 8	€10.30
9	EG TEK 43 B9	7x5	Assembly 9	€13.55



OUR TIP: EQUIP THE INSERT YOURSELF!

Inserts are also available unassembled! Using the grid, they are easily and individually equipped with individual insert boxes. Insert boxes of various sizes and colours can be found on page 70 »

INSERT BOXES INSERT EURO CONTAINERS 60 x 40 cm

AVAILABLE UP FROM 1 PIECE
no minimum purchase order.

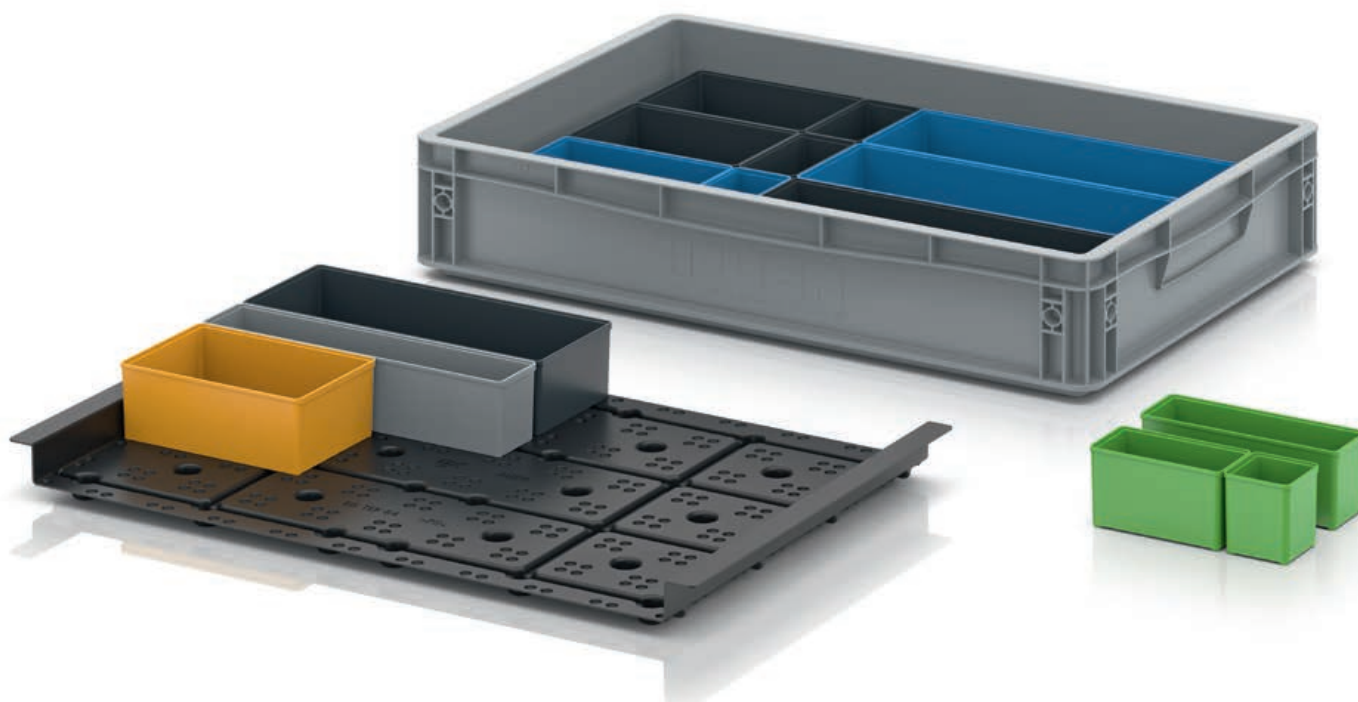

READY FOR DISPATCH within **24** hours **

Fixed positioning

The insertable bin insert allows the spacing created by using insertable bins in Euro containers to be balanced precisely. The insert has recesses in which the insertable bins snap into place according to the building block principle.

- For Euro container basic dimensions of 40 x 30 and 60 x 40 cm
- Insertable bins are perfectly secured in Euro containers
- Anti-slip positioning even when not fully packed
- Low dead weight

INSERTABLE BIN INSERTS FOR EURO CONTAINERS 60 x 40 cm

Article No.	Grid	Loading	Unit price
EG TEK 64	10x7	unloaded	€8.70

» You can find insertable bins on page 70

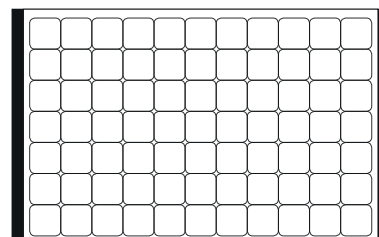

***) only for orders placed via the online shop. Dispatch only on working days, provided the goods are in stock. Information regarding availability and current dispatch times can be found in the online shop.



INSERTABLE BIN INSERTS FOR EURO CONTAINERS 60 × 40 cm

Article No.	Grid	Loading	Unit price	
1	EG TEK 64 B1	10x7	Assembly 1	€14.08
2	EG TEK 64 B2	10x7	Assembly 2	€9.38
3	EG TEK 64 B3	10x7	Assembly 3	€10.12
4	EG TEK 64 B4	10x7	Assembly 4	€8.52
5	EG TEK 64 B5	10x7	Assembly 5	€9.85
6	EG TEK 64 B6	10x7	Assembly 6	€8.91
7	EG TEK 64 B7	10x7	Assembly 7	€11.08
8	EG TEK 64 B8	10x7	Assembly 8	€8.25
9	EG TEK 64 B9	10x7	Assembly 9	€12.38



OUR TIP: EQUIP THE INSERT YOURSELF!

Inserts are also available unassembled! Using the grid, they are easily and individually equipped with individual insert boxes. Insert boxes of various sizes and colours can be found on page 70 »

BOX INSERTS FOR 60 x 40 cm EURO CONTAINERS

READY FOR DISPATCH **24** hours**
within

AVAILABLE UP FROM 1 PIECE
no minimum purchase order.



Arrange & organise glasses and components

AUER Packaging's box insert for Euro containers brings order to the storage and transportation of glasses or components. The "bottom" insert is laid directly into the container, while the "top" insert is placed onto the container using two bars on the front of it and then pressed firmly into the container's handle opening.

» ESD version available in our online shop

- Holds the contents securely in place
- Sturdy internal compartments
- Good washing and drying results
- Various designs

PLEASE NOTE

The box insert 'top' is only suitable for Euro containers with open handles! Special ridges on the short sides of the insert can be hooked into the open handle of the container, ensuring a secure hold. The 'bottom' version is placed directly in the Euro container and can therefore be used without handles.

For more special compartments, go to page 42 »

***) only for orders placed via the online shop. Dispatch only on working days, provided the goods are in stock. Information regarding availability and current dispatch times can be found in the online shop.



BOX INSERTS FOR 60 x 40 cm EURO CONTAINERS

RAL 7001

Article No.	Design	Hole diameter (cm)	Price for single unit	Units on pallet	Unit price on pallet
1	Gef 12 o	12 holes 13.7 x 11.7 cm top	€5.15	240	€3.96
2	Gef 12 u	12 holes 13.7 x 11.7 cm bottom	€5.15	240	€3.96
3	Gef 15 o	15 holes 10.9 x 11.7 cm top	€5.78	240	€4.44
4	Gef 15 u	15 holes 10.9 x 11.7 cm bottom	€5.78	240	€4.44
5	Gef 24 o	24 holes 9.0 x 8.6 cm top	€4.80	240	€3.69
6	Gef 24 u	24 holes 9.0 x 8.6 cm bottom	€4.80	240	€3.69
7	Gef 40 o	40 holes 6.7 x 6.7 cm top	€7.17	240	€5.51
8	Gef 40 u	40 holes 6.7 x 6.7 cm bottom	€7.17	240	€5.51



9 | SPACER CLASSIC

RAL 7001

Outer dimensions L x W (cm)	Article No.	Price for single unit	Units on pallet	Unit price on pallet
36.5 x 26.5	ZP43	€7.05	500	€5.42
57.0 x 36.5	ZP64	€15.67	500	€12.05
77.0 x 57.0	ZP86	€32.72	500	€25.17

INDIVIDUALISED INSERTS FOR EURO CONTAINERS



AVAILABLE UP FROM 1 PIECE
no minimum purchase order.

PARTIONS FOR EURO CONTAINERS

Even better sorting

Longitudinal and transverse dividers that make sorting within a container significantly easier can also be integrated in Euro containers with their smooth side walls without any problems. This is made possible by precisely fitting side panels that are equipped with multiple guide slots. Partitions made up of a combination of longitudinal and transverse dividers are also possible.

- Clean subdivision of Euro containers
- Fixed in guide slots to prevent slipping
- For Euro container basic dimensions of 40 × 30 and 60 × 40 cm
- Different dividers possible for each container size

OUR TIP: CONFIGURE INSERTS ONLINE

In our online shop, you can individually configure special compartments as well as longitudinal and cross dividers for Euro containers. Simply choose the basic size of the container, the height of the insert and the desired divider.

Order online now: www.auer-packaging.com

AVAILABLE UP FROM 1 PIECE
no minimum purchase order.



Individually subdivided

AUER Packaging's special compartments enable you to subdivide Euro containers exactly as you wish. The practical dividers can be custom-made for you upon request. Please note that the special compartments can only be configured in the online shop.

» Find ESD version on page 228

- Very stable
- Custom-made
- Precisely pre-cut connector system
- Matched to EURO dimensions

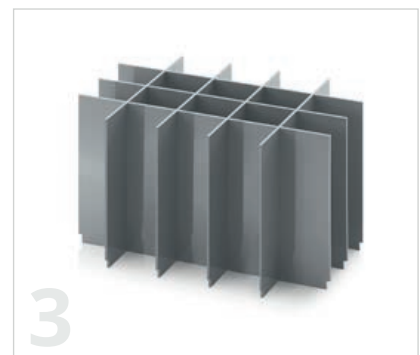
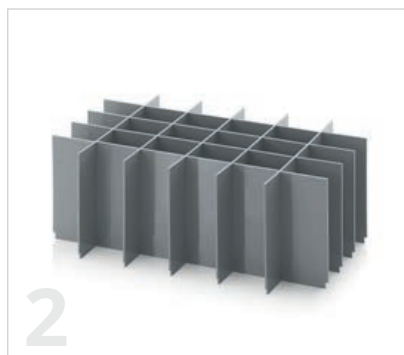
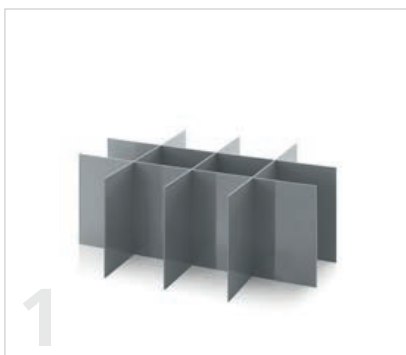

SPECIAL COMPARTMENTS FOR EURO CONTAINERS

RAL 7001

Article No.	Design	Height	Length divider	Cross divider	Unit price
EG SGF 43xx	Set for base dimension 40 x 30 cm	4.5 - 29 cm	1 - 10	1 - 10	starting at €5.88
EG SGF 64xx	Set for base dimension 60 x 40 cm	4.5 - 39 cm	1 - 10	1 - 10	starting at €6.28
EG SGF 86xx	Set for base dimension 80 x 60 cm	8 - 38 cm	1 - 10	1 - 10	starting at €8.20



CUBED FOAM FOR EURO CONTAINERS

AVAILABLE UP FROM 1 PIECE
no minimum purchase order.



READY FOR DISPATCH within **24** hours **

Soft padding all around

The cubed foam variant is ideal when the contents of Euro containers are to be stowed in a non-slip and shockproof manner. The pre-punched cube structure enables precise adjustment of the pad to the content, for example to a camera or measurement device. Multiple pad inserts are used depending on the height of the container, which means that the shape of the content can be reproduced three-dimensionally.

- Individual adaptation to the most diverse objects
- Reliable anti-slip and impact protection
- Three-dimensional adjustment to the content possible

CUBED FOAM FOR EURO CONTAINERS

RAL 7016

Article No.	Dimensions L x W x H (cm)	Suitable for	Material	Unit price
EG S SEWW 43/75	37 x 27 x 6	EG 43/75 HG, ED 43/75 HG	PU	€11.99
EG S SEWW 43/12	37 x 27 x 11	EG 43/12 HG, ED 43/12 HG	PU	€21.87
EG S SEWW 43/17	37 x 27 x 16	EG 43/17 HG, ED 43/17 HG	PU	€31.75
EG S SEWW 43/22	37 x 27 x 21	EG 43/22 HG, ED 43/22 HG	PU	€41.62
EG S SEWW 43/27	37 x 27 x 26	EG 43/27 HG, ED 43/27 HG	PU	€51.50
EG S SEWW 43/32	37 x 27 x 31	EG 43/32 HG, ED 43/32 HG	PU	€61.38
EG S SEWW 64/75	56 x 36 x 6	EG 64/75 HG, ED 64/75 HG	PU	€17.14
EG S SEWW 64/12	56 x 36 x 11	EG 64/12 HG, ED 64/12 HG	PU	€30.85
EG S SEWW 64/17	56 x 36 x 16	EG 64/17 HG, ED 64/17 HG	PU	€44.56
EG S SEWW 64/22	56 x 36 x 21	EG 64/22 HG, ED 64/22 HG	PU	€58.27
EG S SEWW 64/27	56 x 36 x 26	EG 64/27 HG, ED 64/27 HG	PU	€71.98
EG S SEWW 64/32	56 x 36 x 31	EG 64/32 HG, ED 64/32 HG	PU	€85.69
EG S SEWW 64/42	56 x 36 x 41	EG 64/42 HG, ED 64/42 HG	PU	€113.11

FOAM-INLAY FOR EURO CONTAINERS

RAL 7016

Article No.	Dimensions L x W x H (cm)	Suitable for	Material	Unit price
EG SEDW 43	34 x 24 x 0.75	ED 40 x 30, DE 43	PU	€6.48
EG SEDW 64	54 x 34 x 0.75	ED 60 x 40, DE 64	PU	€8.29

OUR TIP:

Order the appropriate foam inlay at the same time to protect the contents!

***) only for orders placed via the online shop. Dispatch only on working days, provided the goods are in stock. Information regarding availability and current dispatch times can be found in the online shop.

HAND TROLLEY EURO CONTAINERS

AVAILABLE UP FROM 1 PIECE
no minimum purchase order.



Safely transported

AUER Packaging's Euro container hand trolley is adapted to match the commonly used Euro dimensions and consequently enables easy and safe transport of full Euro containers. Its ergonomic design enhances operator comfort during handling.

- Ergonomic
- Matched to EURO dimensions
- Carrying capacity up to 160 kg
- Especially smooth-running wheels

HAND TROLLEY EURO CONTAINERS BASEPLATE 60 x 40 cm

RAL 7016

Article No.	Design	Carrying load	Price for single unit	Units on pallet	Unit price on pallet
SK EG	without height adjustment	160 kg	€284.70	9	€219.00
SK V EG	with height adjustment	160 kg	€316.21	9	€243.24

COVER FOR HANDLES FOR EURO CONTAINERS

AVAILABLE UP FROM 1 PIECE
no minimum purchase order.

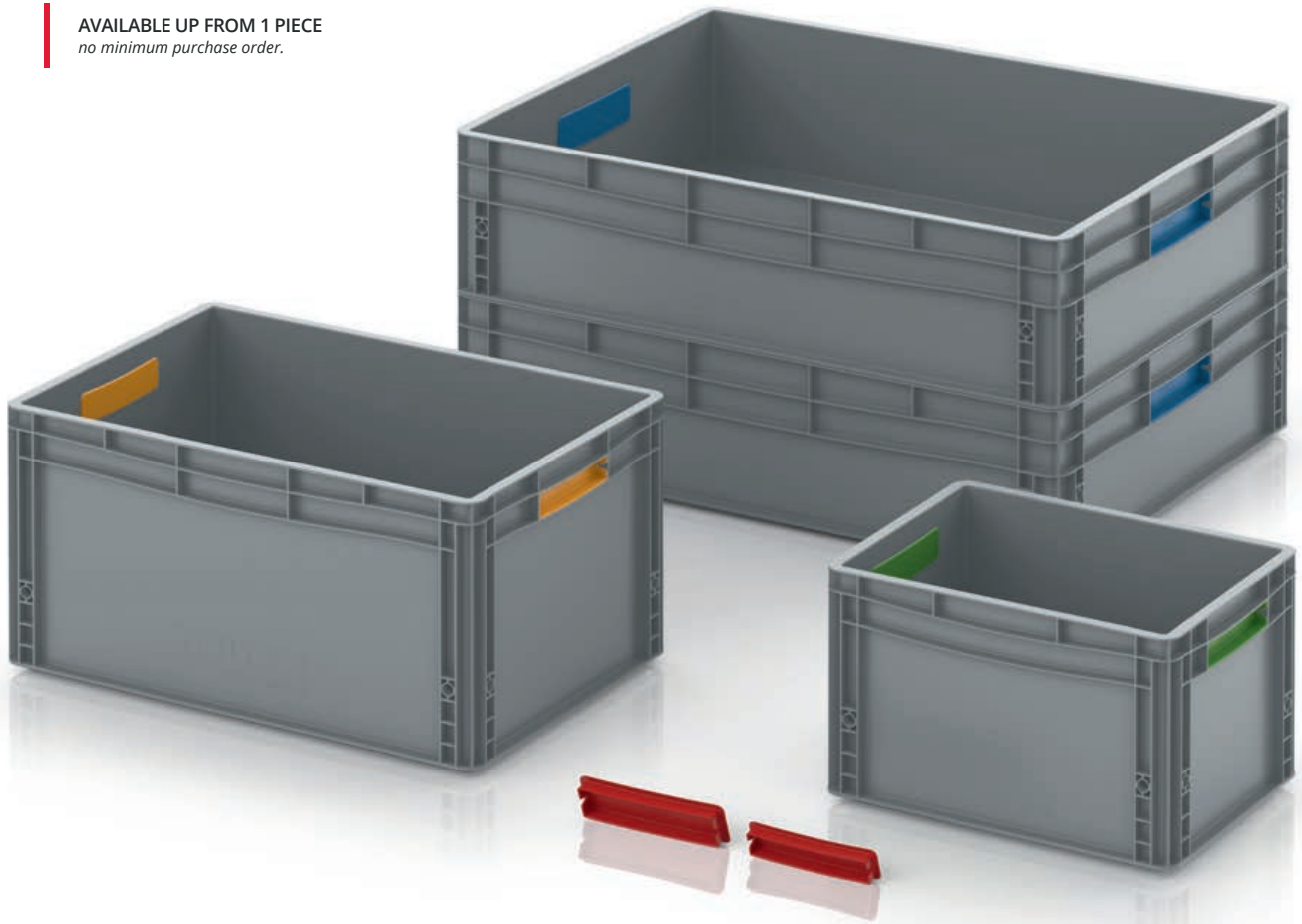

READY FOR DISPATCH **24** hours**

Colourful transformation

With the help of handle covers, you can turn Euro containers with open handles into completely closed containers at a later time. Simply clip onto the openings – and you are done! If you want to easily colour code your containers, you can choose from six different colours for the covers.

- Subsequent upgrading
- Simple installation and replacement
- For handles on the front
- Six different standard colours

COVER FOR HANDLES FOR EURO CONTAINERS

Suitable for basic dimension	Article No.	Article No.	Article No.	Article No.	Article No.	Article No.	Unit price
40 x 30 – 60 x 40	EG HA 4364-1003	EG HA 4364-3020	EG HA 4364-5015	EG HA 4364-6018	EG HA 4364-7001	EG HA 4364-7016	€0.77
80 x 60	EG HA 86-1003	EG HA 86-3020	EG HA 86-5015	EG HA 86-6018	EG HA 86-7001	EG HA 86-7016	€0.84



STANDARD COLOURS



RAL 1003
signal yellow



RAL 3020
traffic red



RAL 5015
sky blue



RAL 6018
yellow green



RAL 7001
silver grey



RAL 7016
anthracite grey

***) only for orders placed via the online shop. Dispatch only on working days, provided the goods are in stock. Information regarding availability and current dispatch times can be found in the online shop.

ACCESSORIES EURO CONTAINERS



1 | PLACE-ON LIDS FOR EURO CONTAINERS

RAL 7001

Suitable for basic dimension	Article No.	Price for single unit	Units on pallet	Unit price on pallet
20 x15	DE 215	€0.89	8640	€0.69
30 x20	DE 32	€1.27	4140	€0.98
40 x30	DE 43	€3.62	800	€2.79
60 x40	DE 64	€4.45	600	€3.43
80 x60	DE 86	€13.26	50	€10.20



2 | CLIP-ON LID FOR EURO CONTAINERS

RAL 9017

Suitable for basic dimension	Article No.	Price for single unit	Units on pallet	Unit price on pallet
30 x20	A 32	€4.31	879	€3.32
40 x30	A 43	€12.06	756	€9.27
60 x40	A 64	€11.23	400	€8.64
80 x60	A 86	€25.54	145	€19.65



3 | PLACE-ON LIDS FOR PALLETS MULTI-PURPOSE

RAL 9017

Suitable for basic dimension	Article No.	Price for single unit	Units per stack on truck	Unit price on truck
120 x 80	A 1208	€42.68	100	€32.83
120 x 100	A 1210	€44.49	100	€34.22

4 | PLACE-ON LIDS FOR PALLETS KLT

RAL 5012

RAL 4008

Suitable for basic dimension	Article No.	Colour	Price for single unit	Units on pallet	Unit price on pallet
120 x 80	A 1208-1	light blue	€28.43	50	€21.87
120 x 100	A 1210-1	light blue	€31.79	50	€24.45
120 x 80	A 1208-1 BMW	signal violet	€28.86	50	€22.20

» Find ESD version on page 230



OTHER ACCESSORIES

Article No.	Description	Unit price
5 E KG G	Foldable handle for self-assembly	€11.61
6 ET	Label clip can be attached to containers	€0.96



CUSTOM-SIZED CONTAINERS

Individual and precise



CUSTOM-SIZED CONTAINERS

AVAILABLE UP FROM 1 PIECE
no minimum purchase order.



Individual and precise

You appreciate the functionality and quality of Euro containers but have a job for which you need other sizes than those offered by the Euro format? We are happy to offer custom-sized containers starting from 18 x 18 x 17 cm. They will be produced in the exact sizes required!

There is no limit, as long as the statics allows it.

- Practically any size possible
- Stable frame
- High-quality plates for bottom and sides
- Suitable for automation

EXAMPLES OF CUSTOM-SIZED CONTAINERS



Custom-sized containers
33 x 44 x 17 cm
 Unit price

€426.⁹⁷

Outer dimensions L x W x H (cm)	Article No.	1 piece per unit	10 pieces per unit	100 pieces per unit
33 x 44 x 17	SMB	€426.97	€291.97	€278.47



Custom-sized containers
88 x 18 x 17 cm
 Unit price

€439.⁹⁵

Outer dimensions L x W x H (cm)	Article No.	1 piece per unit	10 pieces per unit	100 pieces per unit
88 x 18 x 17	SMB	€439.95	€304.95	€291.45



Custom-sized containers
120 x 40 x 17 cm
 Unit price

€473.²²

Outer dimensions L x W x H (cm)	Article No.	1 piece per unit	10 pieces per unit	100 pieces per unit
120 x 40 x 17	SMB	€473.22	€338.22	€324.72

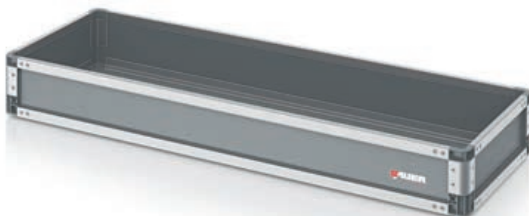

Custom-sized containers
145 x 25 x 20 cm
 Unit price

€478.³⁰

Outer dimensions L x W x H (cm)	Article No.	1 piece per unit	10 pieces per unit	100 pieces per unit
145 x 25 x 20	SMB	€478.30	€343.30	€329.80

OUR TIP:

Configure and calculate the price of your custom-sized containers online: www.auer-packaging.com/smb



KLT BOXES

Seamless integration



R-KLT CONTAINERS

AVAILABLE UP FROM 1 PIECE
no minimum purchase order.

SPECIAL COLOURS
Simply order online

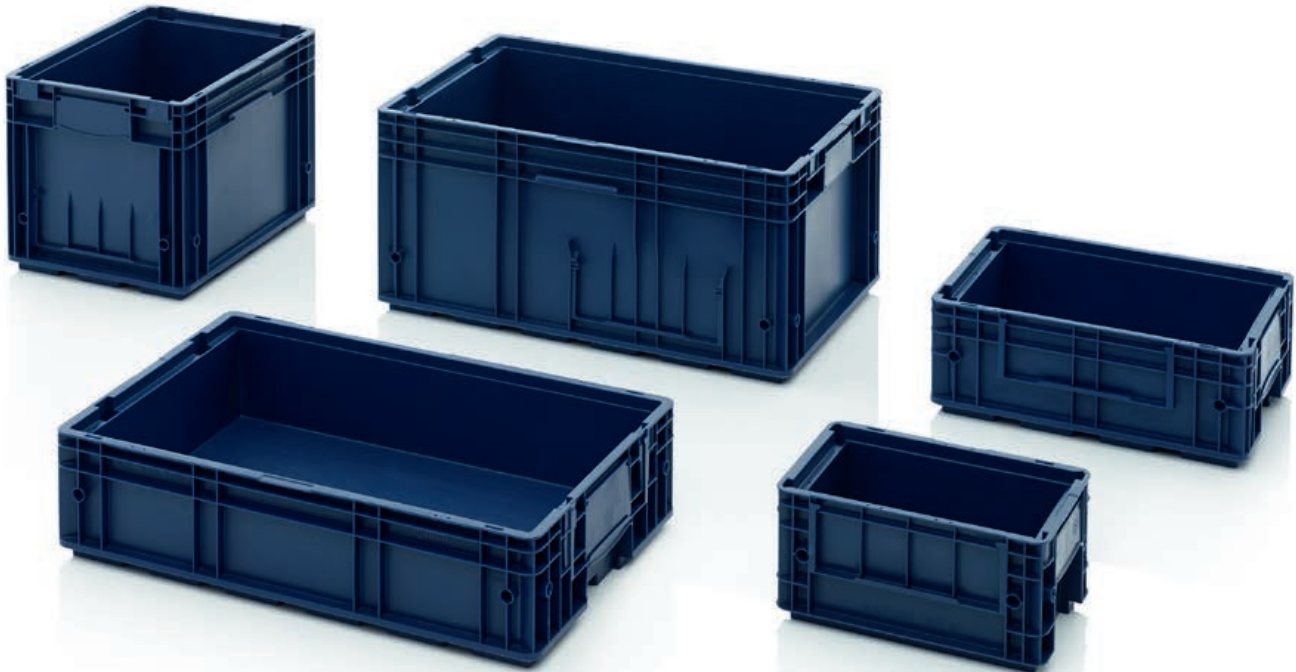

READY FOR DISPATCH
within **24 hours** 

Seamless integration

AUER Packaging's R-KLT container is perfectly adapted to automated production processes and suitable for use during different stages of production. The R-KLT container features an extremely stable ribbed base.

- Extremely stable ribbed base
- Withstands temperatures from -20° to 100°C
- With surface for barcodes
- Built-in lid slits

R-KLT CONTAINERS

RAL 5003

Outer dimensions L x W x H (cm)	Article No.	Base design	Price for single unit	Units on pallet	Unit price on pallet
30 x20 x14.7	R-KLT 3215	Smooth, closed	€3.32	320	€2.55
40 x30 x14.7	R-KLT 4315	Sturdy base ribbing, closed	€7.19	160	€5.53
40 x30 x28.0	R-KLT 4329	Sturdy base ribbing, closed	€10.34	80	€7.95
60 x40 x14.7	R-KLT 6415	Sturdy base ribbing, closed	€11.83	80	€9.10
60 x40 x28.0	R-KLT 6429	Sturdy base ribbing, closed	€16.79	40	€12.91

» Find ESD version on page 220



***) only for orders placed via the online shop. Dispatch only on working days, provided the goods are in stock. Information regarding availability and current dispatch times can be found in the online shop.

RL-KLT CONTAINERS

AVAILABLE UP FROM 1 PIECE
no minimum purchase order.

SPECIAL COLOURS
Simply order online

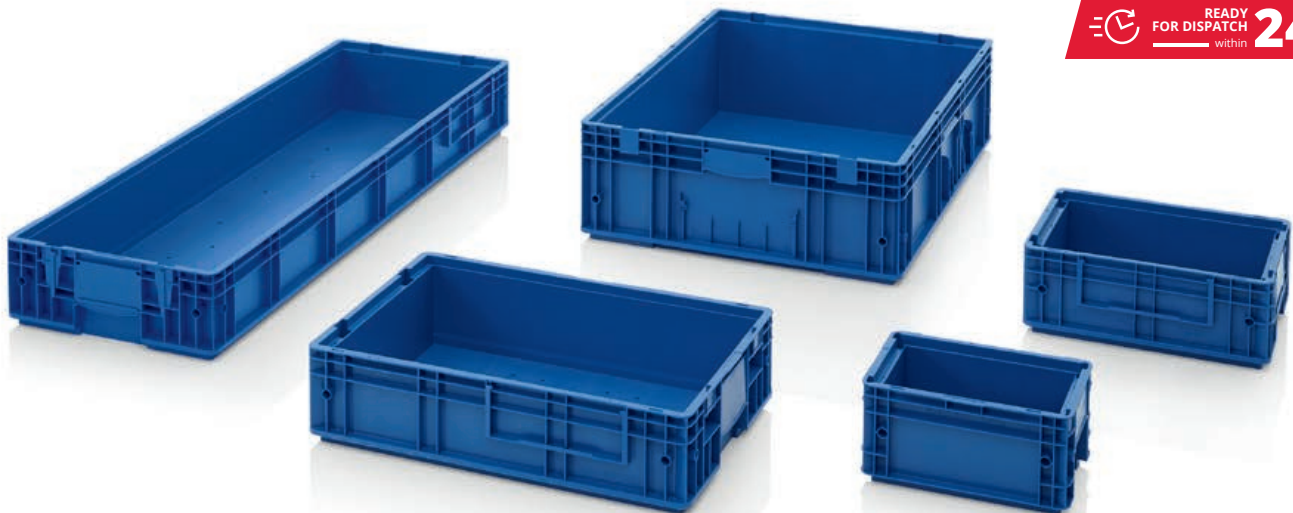

READY FOR DISPATCH within **24** hours**

Keep everything flowing

AUER Packaging's RL-KLT container features a smooth base and incorporates drainage holes according to VDS classification directive BG 4.3 (except for the RL-KLT 3147). Safe and convenient working is guaranteed with the RL-KLT container!

- Smooth underside
- Withstands temperatures from -20° to 100°C
- Space for barcodes
- Built-in lid slits

RL-KLT CONTAINERS

RAL 5005

Outer dimensions L x W x H (cm)	Article No.	Base design	Price for single unit	Units on pallet	Unit price on pallet
30 x20 x14.7	RL-KLT 3147	Smooth, closed	€3.31	320	€2.55
40 x30 x14.7	RL-KLT 4147	Smooth, closed with drainage holes	€6.23	160	€4.79
40 x30 x28.0	RL-KLT 4280	Smooth, closed with drainage holes	€9.64	80	€7.41
60 x40 x14.7	RL-KLT 6147	Smooth, closed with drainage holes	€10.15	80	€7.81
60 x40 x28.0	RL-KLT 6280	Smooth, closed with drainage holes	€15.01	40	€11.54

» Find ESD version on page 221



MAXI KLT CONTAINERS

RAL 5005

Outer dimensions L x W x H (cm)	Article No.	Base design	Price for single unit	Units on pallet	Unit price on pallet
80 x60 x22.0	RL-KLT 8210 g	Smooth, closed with drainage holes	€22.61	20	€17.39
120 x40 x14.7	KLT 12415	Reinforced, closed	€40.30	32	€31.00

» Find ESD version on page 221



***) only for orders placed via the online shop. Dispatch only on working days, provided the goods are in stock. Information regarding availability and current dispatch times can be found in the online shop.

FOLDABLE KLT BOXES

READY FOR DISPATCH **24** hours**
within

AVAILABLE UP FROM 1 PIECE
no minimum purchase order.

SPECIAL COLOURS
Simply order online



Maximum efficiency

AUER Packaging's foldable KLT container combines the advantages of the small load carrier series for the automotive industry with the space-saving properties of foldable boxes. When not in use, the volume of the foldable KLT container can be reduced by up to 70%.

- Up to 70% reduction in volume
- Quiet running on conveyors
- Fully recyclable
- With adhesive surfaces for barcode

FOLDABLE KLT BOXES

RAL 5012

Outer dimensions L x W x H (cm)	Article No.	Base design	Price for single unit	Units on pallet	Unit price on pallet
60 x 40 x 28	F-KLT 6410	Sturdy base ribbing, closed	€21.11	135	€16.24
60 x 40 x 28	F-KLT 6410 G	Smooth, closed	€18.78	135	€14.44

» Find ESD version on page 222



FOLDABLE KLT BOXES

RAL 4008

Outer dimensions L x W x H (cm)	Article No.	Base design	Price for single unit	Units on pallet	Unit price on pallet
60 x 40 x 28	F-KLT 6410 BMW	Sturdy base ribbing, closed	€21.40	135	€16.46



***) only for orders placed via the online shop. Dispatch only on working days, provided the goods are in stock.
Information regarding availability and current dispatch times can be found in the online shop.

ACCESSORIES KLT BOXES



LID FOR R-KLT

RAL 5003

	Suitable for basic dimension	Article No.	Price for single unit	Units on pallet	Unit price on pallet
1	30 x 20	R-KLT-D 35	€1.08	1600	€0.83
2	40 x 30	R-KLT-D 45	€2.12	880	€1.63
3	60 x 40	R-KLT-D 65	€4.18	600	€3.22



LID FOR RL-KLT

RAL 5005

	Suitable for basic dimension	Article No.	Price for single unit	Units on pallet	Unit price on pallet
4	30 x 20	RL-KLT-D 35	€1.08	1600	€0.83
5	40 x 30	RL-KLT-D 45	€2.11	880	€1.63
6	60 x 40	RL-KLT-D 65	€4.17	600	€3.21



PLACE-ON LIDS FOR PALLETS KLT FOR KLT CONTAINERS

RAL 5012

RAL 4008

	Suitable for basic dimension	Article No.	Colour	Price for single unit	Units on pallet	Unit price on pallet
7	120 x 80	A 1208-1	light blue	€28.43	50	€21.87
8	120 x 100	A 1210-1	light blue	€31.79	50	€24.45
9	120 x 80	A 1208-1 BMW	signal violet	€28.86	50	€22.20

» Find ESD version on page 230



Pallet prices apply only for full pallets. Prices exclusive VAT.



SYSTEM BOXES & CASES

Tidiness meets functionality



ASSORTMENT BOXES 30 x 20 cm

AVAILABLE UP FROM 1 PIECE
no minimum purchase order.



READY FOR DISPATCH within **24** hours**

Properly arranged

AUER Packaging's assortment box is a handy solution for the storage and sorting of small parts. It can be individually configured using various insertable bins. Special details ensure that it is easy to use, such as the spring-loaded lid which is automatically securely locked by pressing down.

- Individually configurable
- Spring-loaded lid
- Automatic lid locking
- Ergonomic handle for folding down

ASSORTMENT BOX UNLOADED 30 x 20 cm

RAL 7016

Outer dimensions L x W x H (cm)	Article No.	Grid	Price for single unit	Units on pallet	Unit price on pallet
30 x 20.0 x 7.1	SB 32	5x3	€11.73	600	€9.02

» Insertable bins and carrying strap can be found as from page 70

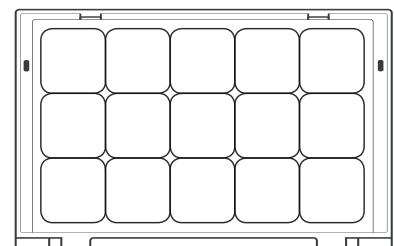

***) only for orders placed via the online shop. Dispatch only on working days, provided the goods are in stock. Information regarding availability and current dispatch times can be found in the online shop.



ASSORTMENT BOX LOADED 30 x 20 cm

RAL 7016

	Outer dimensions L x W x H (cm)	Article No.	Grid	Loading	Price for single unit	Units on pallet	Unit price on pallet
1	30 x20.0 x7.1	SB 32 B1	5x3	Assembly 1	€20.01	600	€15.39
2	30 x20.0 x7.1	SB 32 B2	5x3	Assembly 2	€17.47	600	€13.44
3	30 x20.0 x7.1	SB 32 B3	5x3	Assembly 3	€17.18	600	€13.22
4	30 x20.0 x7.1	SB 32 B4	5x3	Assembly 4	€17.16	600	€13.20
5	30 x20.0 x7.1	SB 32 B5	5x3	Assembly 5	€16.38	600	€12.60
6	30 x20.0 x7.1	SB 32 B6	5x3	Assembly 6	€18.45	600	€14.20
7	30 x20.0 x7.1	SB 32 B7	5x3	Assembly 7	€16.94	600	€13.03
8	30 x20.0 x7.1	SB 32 B8	5x3	Assembly 8	€18.72	600	€14.40
9	30 x20.0 x7.1	SB 32 B9	5x3	Assembly 9	€17.82	600	€13.71



OUR TIP: ASSEMBLE YOUR OWN ASSORTMENT BOX

Assortment boxes are also available unassembled! Using the grid, they are easily and individually equipped with individual insert boxes. Insert boxes of various sizes and colours can be found on page 70 »

ASSORTMENT BOXES 35 x 29.5 cm

AVAILABLE UP FROM 1 PIECE
no minimum purchase order.



READY FOR DISPATCH **24** hours**
within



Properly arranged

AUER Packaging's assortment box is a handy solution for the storage and sorting of small parts. It can be individually configured using various insertable bins. Special details ensure that it is easy to use, such as the spring-loaded lid which is automatically securely locked by pressing down.

- Individually configurable
- Spring-loaded lid
- Automatic lid locking
- Ergonomic handle for folding down

ASSORTMENT BOX UNLOADED 35 x 29.5 cm

RAL 7016

Outer dimensions L x W x H (cm)	Article No.	Grid	Price for single unit	Units on pallet	Unit price on pallet
35 x 29.5 x 7.1	SB 353	6x5	€15.13	330	€11.64

» Insertable bins and carrying strap can be found as from page 70

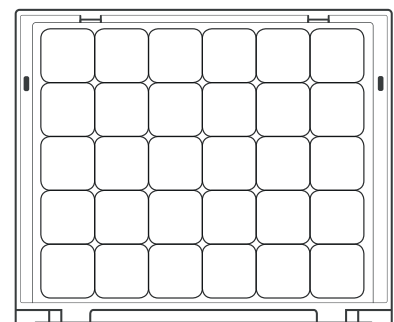

***) only for orders placed via the online shop. Dispatch only on working days, provided the goods are in stock. Information regarding availability and current dispatch times can be found in the online shop.



OUR TIP: ASSEMBLE YOUR OWN ASSORTMENT BOX

Assortment boxes are also available unassembled! Using the grid, they are easily and individually equipped with individual insert boxes. Insert boxes of various sizes and colours can be found on page 70 »

ASSORTMENT BOX LOADED 35 x 29.5 cm

RAL 7016

	Outer dimensions L x W x H (cm)	Article No.	Grid	Loading	Price for single unit	Units on pallet	Unit price on pallet
1	35 x29.5 x7.1	SB 353 B1	6x5	Assembly 1	€30.47	330	€23.44
2	35 x29.5 x7.1	SB 353 B2	6x5	Assembly 2	€26.12	330	€20.09
3	35 x29.5 x7.1	SB 353 B3	6x5	Assembly 3	€25.36	330	€19.51
4	35 x29.5 x7.1	SB 353 B4	6x5	Assembly 4	€24.82	330	€19.09
5	35 x29.5 x7.1	SB 353 B5	6x5	Assembly 5	€21.86	330	€16.82
6	35 x29.5 x7.1	SB 353 B6	6x5	Assembly 6	€25.10	330	€19.31
7	35 x29.5 x7.1	SB 353 B7	6x5	Assembly 7	€24.71	330	€19.01
8	35 x29.5 x7.1	SB 353 B8	6x5	Assembly 8	€26.99	330	€20.76
9	35 x29.5 x7.1	SB 353 B9	6x5	Assembly 9	€22.61	330	€17.40
10	35 x29.5 x7.1	SB 353 B10	6x5	8 screwdrivers 1 x SB E 11 1 x SB E 12 1 x SB E 13	€101.03	330	€77.72
11	35 x29.5 x7.1	SB 353 B11	6x5	7 Torx screwdrivers 2 x SB E 23	€95.16	330	€73.20
12	35 x29.5 x7.1	SB 353 B12	6x5	4 pliers	€136.41	330	€104.93
13	35 x29.5 x7.1	SB 353 B13	6x5	8 double open-ended spanners	€105.99	330	€81.53



ASSORTMENT BOXES 40 x 30 cm

AVAILABLE UP FROM 1 PIECE
no minimum purchase order.



READY FOR DISPATCH within **24** hours**



Properly arranged

AUER Packaging's assortment box is a handy solution for the storage and sorting of small parts. It can be individually configured using various insertable bins. Special details ensure that it is easy to use, such as the spring-loaded lid which is automatically securely locked by pressing down.

- Individually configurable
- Spring-loaded lid
- Automatic lid locking
- Ergonomic handle for folding down

ASSORTMENT BOX UNLOADED 40 x 30 cm

RAL 7016

Outer dimensions L x W x H (cm)	Article No.	Grid	Price for single unit	Units on pallet	Unit price on pallet
40 x 30.0 x 7.1	SB 43	7x5	€16.62	310	€12.78

» Insertable bins and carrying strap can be found as from page 70

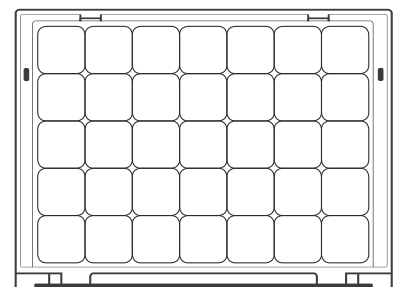

***) only for orders placed via the online shop. Dispatch only on working days, provided the goods are in stock. Information regarding availability and current dispatch times can be found in the online shop.



ASSORTMENT BOX LOADED 40 x 30 cm

RAL 7016

	Outer dimensions L x W x H (cm)	Article No.	Grid	Loading	Price for single unit	Units on pallet	Unit price on pallet
1	40 x30.0 x7.1	SB 43 B1	7x5	Assembly 1	€34.31	310	€26.39
2	40 x30.0 x7.1	SB 43 B2	7x5	Assembly 2	€27.70	310	€21.31
3	40 x30.0 x7.1	SB 43 B3	7x5	Assembly 3	€30.82	310	€23.71
4	40 x30.0 x7.1	SB 43 B4	7x5	Assembly 4	€27.08	310	€20.83
5	40 x30.0 x7.1	SB 43 B5	7x5	Assembly 5	€25.36	310	€19.51
6	40 x30.0 x7.1	SB 43 B6	7x5	Assembly 6	€25.74	310	€19.80
7	40 x30.0 x7.1	SB 43 B7	7x5	Assembly 7	€26.99	310	€20.76
8	40 x30.0 x7.1	SB 43 B8	7x5	Assembly 8	€24.77	310	€19.05
9	40 x30.0 x7.1	SB 43 B9	7x5	Assembly 9	€28.55	310	€21.96



OUR TIP: ASSEMBLE YOUR OWN ASSORTMENT BOX

Assortment boxes are also available unassembled! Using the grid, they are easily and individually equipped with individual insert boxes. Insert boxes of various sizes and colours can be found on page 70 »

ASSORTMENT BOXES 44 x 35.5 cm

AVAILABLE UP FROM 1 PIECE
no minimum purchase order.



READY FOR DISPATCH within **24 hours** **



Properly arranged

AUER Packaging's assortment box is a handy solution for the storage and sorting of small parts. It can be individually configured using various insertable bins. Special details ensure that it is easy to use, such as the spring-loaded lid which is automatically securely locked by pressing down.

- Individually configurable
- Spring-loaded lid
- Automatic lid locking
- Ergonomic handle for folding down

ASSORTMENT BOXES UNLOADED 44 x 35.5 cm

RAL 7016

Outer dimensions L x W x H (cm)	Article No.	Grid	Price for single unit	Units on pallet	Unit price on pallet
44 x 35.5 x 7.1	SB 443	8x6	€20.77	180	€15.97

» Insertable bins and carrying strap can be found as from page 70

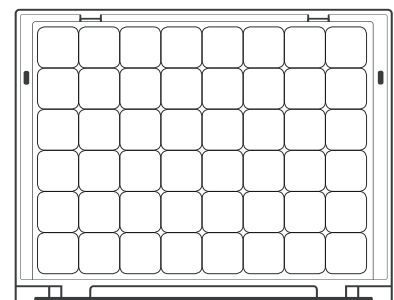

***) only for orders placed via the online shop. Dispatch only on working days, provided the goods are in stock. Information regarding availability and current dispatch times can be found in the online shop.



ASSORTMENT BOXES LOADED 44 x 35.5 cm

RAL 7016

	Outer dimensions L x W x H (cm)	Article No.	Grid	Loading	Price for single unit	Units on pallet	Unit price on pallet
1	44 x35.5 x7.1	SB 443 B1	8x6	Assembly 1	€44.55	180	€34.27
2	44 x35.5 x7.1	SB 443 B2	8x6	Assembly 2	€37.61	180	€28.93
3	44 x35.5 x7.1	SB 443 B3	8x6	Assembly 3	€36.40	180	€28.00
4	44 x35.5 x7.1	SB 443 B4	8x6	Assembly 4	€32.08	180	€24.68
5	44 x35.5 x7.1	SB 443 B5	8x6	Assembly 5	€30.66	180	€23.58
6	44 x35.5 x7.1	SB 443 B6	8x6	Assembly 6	€32.97	180	€25.36
7	44 x35.5 x7.1	SB 443 B7	8x6	Assembly 7	€36.73	180	€28.25
8	44 x35.5 x7.1	SB 443 B8	8x6	Assembly 8	€36.81	180	€28.32
9	44 x35.5 x7.1	SB 443 B9	8x6	Assembly 9	€35.13	180	€27.03



OUR TIP: ASSEMBLE YOUR OWN ASSORTMENT BOX

Assortment boxes are also available unassembled! Using the grid, they are easily and individually equipped with individual insert boxes. Insert boxes of various sizes and colours can be found on page 70 »

ASSORTMENT BOX 60 x 40 cm

AVAILABLE UP FROM 1 PIECE
no minimum purchase order.



Properly arranged

AUER Packaging's assortment box is a handy solution for the storage and sorting of small parts. It can be individually configured using various insertable bins. Special details ensure that it is easy to use, such as the spring-loaded lid which is automatically securely locked by pressing down.

- Individually configurable
- Spring-loaded lid
- Automatic lid locking
- Ergonomic handle for folding down

ASSORTMENT BOX UNLOADED 60 x 40 cm

RAL 7016

Outer dimensions L x W x H (cm)	Article No.	Grid	Price for single unit	Units on pallet	Unit price on pallet
60 x 40.0 x 7.1	SB 64	11x7	€31.11	155	€23.93

» Insertable bins and carrying strap can be found as from page 70

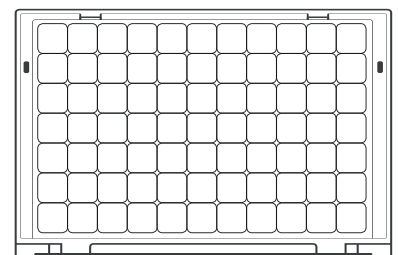

***) only for orders placed via the online shop. Dispatch only on working days, provided the goods are in stock. Information regarding availability and current dispatch times can be found in the online shop.



ASSORTMENT BOX LOADED 60 x 40 cm

RAL 7016

	Outer dimensions L x W x H (cm)	Article No.	Grid	Loading	Price for single unit	Units on pallet	Unit price on pallet
1	60 x40.0 x7.1	SB 64 B1	11x7	Assembly 1	€68.52	155	€52.71
2	60 x40.0 x7.1	SB 64 B2	11x7	Assembly 2	€54.97	155	€42.28
3	60 x40.0 x7.1	SB 64 B3	11x7	Assembly 3	€52.90	155	€40.69
4	60 x40.0 x7.1	SB 64 B4	11x7	Assembly 4	€48.13	155	€37.02
5	60 x40.0 x7.1	SB 64 B5	11x7	Assembly 5	€52.80	155	€40.61
6	60 x40.0 x7.1	SB 64 B6	11x7	Assembly 6	€50.85	155	€39.12
7	60 x40.0 x7.1	SB 64 B7	11x7	Assembly 7	€58.90	155	€45.31
8	60 x40.0 x7.1	SB 64 B8	11x7	Assembly 8	€47.54	155	€36.57
9	60 x40.0 x7.1	SB 64 B9	11x7	Assembly 9	€62.19	155	€47.84



OUR TIP: ASSEMBLE YOUR OWN ASSORTMENT BOX

Assortment boxes are also available unassembled! Using the grid, they are easily and individually equipped with individual insert boxes. Insert boxes of various sizes and colours can be found on page 70 »

ACCESSORIES ASSORTMENT BOXES

AVAILABLE UP FROM 1 PIECE
no minimum purchase order.

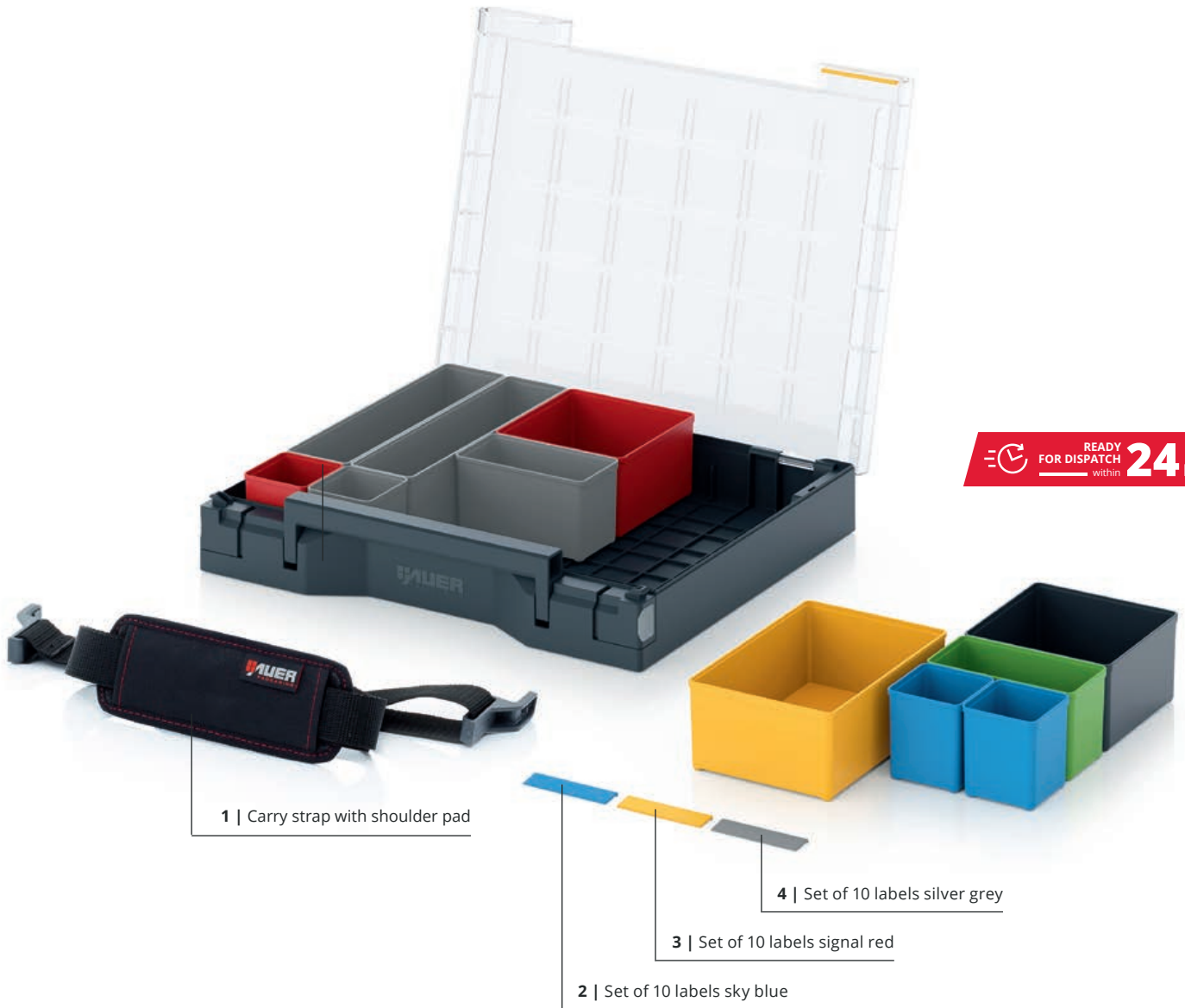

READY FOR DISPATCH **24** hours**
within

ACCESSORIES FOR ASSORTMENT BOXES

Article No.	Description	Price for single unit	Units on pallet	Unit price on pallet
1 SB TG	Carry strap with shoulder pad	€5.32	1000	€4.10
2 SB E-5015 S	Set of 10 labels sky blue	€1.72	1000	€1.32
3 SB E-1003 S	Set of 10 labels signal red	€1.72	1000	€1.32
4 SB E-7001 S	Set of 10 labels silver grey	€1.72	1000	€1.32

***) only for orders placed via the online shop. Dispatch only on working days, provided the goods are in stock. Information regarding availability and current dispatch times can be found in the online shop.

INSERTABLE BINS FOR ASSORTMENT BOXES

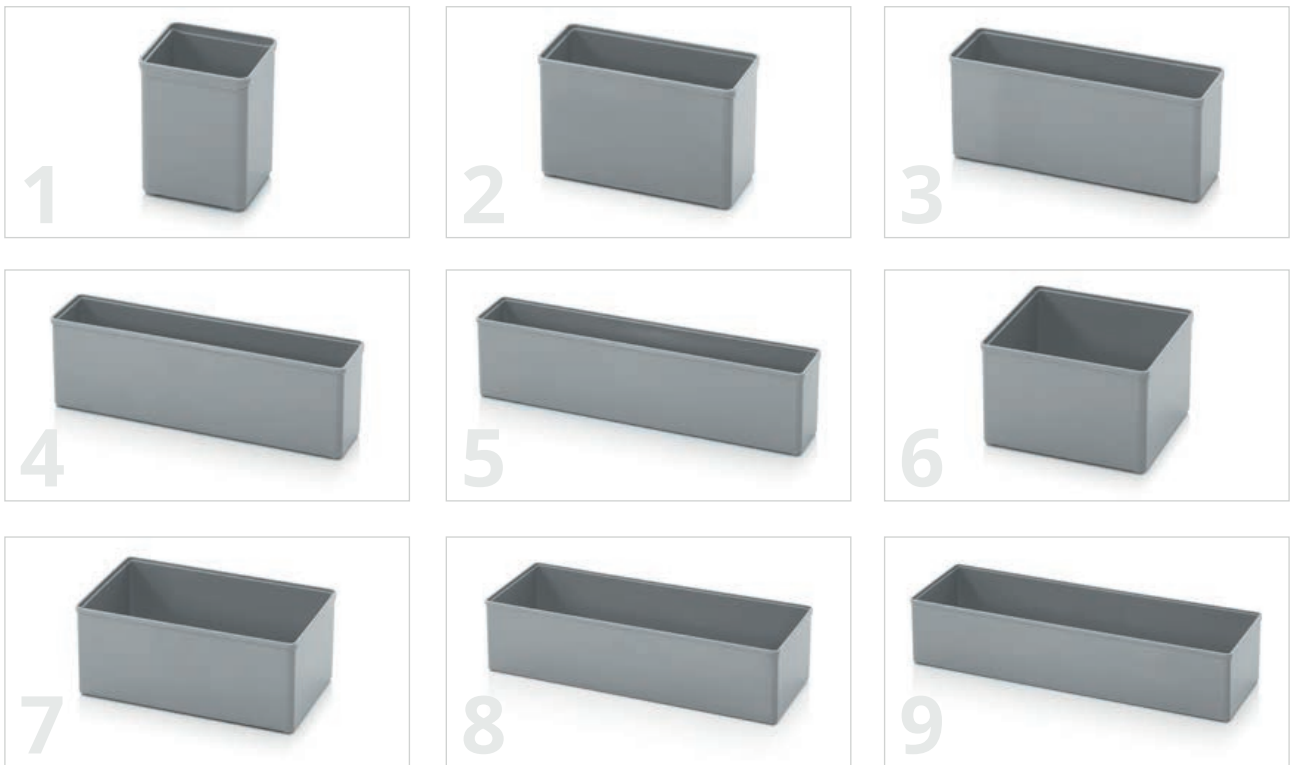

For an extra overview

AUER Packaging's extensive range of insertable bins make it easy to keep tabs on the contents of the assortment boxes that are perfectly adapted to them. Insertable bins can be preconfigured as part of the set including the assortment box or alternatively individually ordered for loading specific contents.

- 9 different sizes
- 6 standard colours
- Pre-defined sets available
- Each item individually configurable

INSERTABLE BINS FOR ASSORTMENT BOXES

	Outer dimensions L x W x H (cm)	Grid size	Article No.	Article No.	Article No.	Article No.	Article No.	Article No.	Price for single unit	Units on pallet	Unit price on pallet
1	5.2 x 5.2 x 6.3	1x1	SB E 11-1003	SB E 11-3020	SB E 11-5015	SB E 11-6018	SB E 11-7001	SB E 11-7016	€0.31	11550	€0.24
2	10.4 x 5.2 x 6.3	1x2	SB E 12-1003	SB E 12-3020	SB E 12-5015	SB E 12-6018	SB E 12-7001	SB E 12-7016	€0.47	5790	€0.36
3	15.6 x 5.2 x 6.3	1x3	SB E 13-1003	SB E 13-3020	SB E 13-5015	SB E 13-6018	SB E 13-7001	SB E 13-7016	€0.69	3960	€0.53
4	20.8 x 5.2 x 6.3	1x4	SB E 14-1003	SB E 14-3020	SB E 14-5015	SB E 14-6018	SB E 14-7001	SB E 14-7016	€0.97	2820	€0.74
5	26.0 x 5.2 x 6.3	1x5	SB E 15-1003	SB E 15-3020	SB E 15-5015	SB E 15-6018	SB E 15-7001	SB E 15-7016	€1.12	2310	€0.86
6	10.4 x 10.4 x 6.3	2x2	SB E 22-1003	SB E 22-3020	SB E 22-5015	SB E 22-6018	SB E 22-7001	SB E 22-7016	€0.70	2970	€0.54
7	15.6 x 10.4 x 6.3	2x3	SB E 23-1003	SB E 23-3020	SB E 23-5015	SB E 23-6018	SB E 23-7001	SB E 23-7016	€1.01	2010	€0.78
8	26.0 x 10.4 x 6.3	2x5	SB E 25-1003	SB E 25-3020	SB E 25-5015	SB E 25-6018	SB E 25-7001	SB E 25-7016	€1.51	1200	€1.16
9	31.2 x 10.4 x 6.3	2x6	SB E 26-1003	SB E 26-3020	SB E 26-5015	SB E 26-6018	SB E 26-7001	SB E 26-7016	€1.80	990	€1.39



STANDARD COLOURS



GRID OF ASSORTMENT BOXES

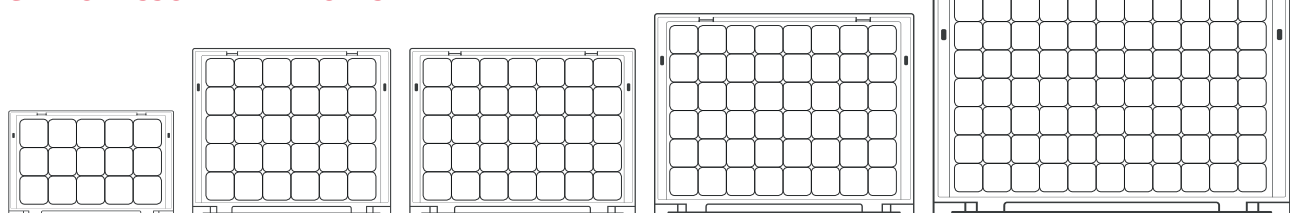

Article No. SB 32

Grid 5 x 3
30 x 20 x 7.1 cm

Article No. SB 353

Grid 6 x 5
35 x 29,5 x 7.1 cm

Article No. SB 43

Grid 7 x 5
40 x 30 x 7.1 cm

Article No. SB 443

Grid 8 x 6
44 x 35,5 x 7.1 cm

Article No. SB 64

Grid 11 x 7
60 x 40 x 7.1 cm



**GERMAN
DESIGN
AWARD
NOMINEE
2018**



TOOL BOXES

Ingeniously linked



TOOL BOXES PRO 40 x 30 cm

AVAILABLE UP FROM 1 PIECE
no minimum purchase order.

READY FOR DISPATCH
within **24** hours**



Ingeniously linked

AUER Packaging's Tool Box Pro is a sophisticated, multi-purpose container for secure storage and transportation of a wide variety of different contents. The patented bayonet fitting enables a fast and secure linking of several tool boxes.

- Patented linking system
- Spring-loaded lid
- Automatic lid locking
- Customised accessories: Padding, deep-drawn inserts, tool carriers and many more besides.

TOOL BOXES PRO 40 x 30 cm

Outer dimensions L x W x H (cm)	Article No.	Article No.	Design	Price for single unit	Units on pallet	Unit price on pallet
40 x 30 x 12.0	TB 4311 F1	TB 4311 F4	without lock	€22.77	200	€17.52
40 x 30 x 17.5	TB 4316 F1	TB 4316 F4	without lock	€25.03	130	€19.26
40 x 30 x 23.0	TB 4322 F1	TB 4322 F4	without lock	€27.41	90	€21.08
40 x 30 x 34.0	TB 4333 F1	TB 4333 F4	without lock	€32.58	60	€25.06
40 x 30 x 45.0	TB 4344 F1	TB 4344 F4	without lock	€38.23	40	€29.41
40 x 30 x 12.0	TB S 4311 F1	TB S 4311 F4	with 1 lock	€43.17	200	€33.21
40 x 30 x 17.5	TB S 4316 F1	TB S 4316 F4	with 1 lock	€45.43	130	€34.95
40 x 30 x 23.0	TB S 4322 F1	TB S 4322 F4	with 1 lock	€47.81	90	€36.77
40 x 30 x 34.0	TB S 4333 F1	TB S 4333 F4	with 1 lock	€52.98	60	€40.75
40 x 30 x 45.0	TB S 4344 F1	TB S 4344 F4	with 1 lock	€58.63	40	€45.10

» Tool box model with lock not compatible with thermoformed inserts and dividers.



STANDARD COLOURS

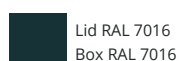

Lid RAL 7016
Box RAL 7016

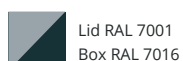

Lid RAL 7001
Box RAL 7016

**) only for orders placed via the online shop. Dispatch only on working days, provided the goods are in stock. Information regarding availability and current dispatch times can be found in the online shop.

TOOL BOXES PRO 60 x 40 cm

AVAILABLE UP FROM 1 PIECE
no minimum purchase order.

READY FOR DISPATCH
within **24 hours**



TOOL BOXES PRO 60 x 40 cm

Outer dimensions L x W x H (cm)	Article No.	Article No.	Design	Price for single unit	Units on pallet	Unit price on pallet
60 x40 x 17.5	TB 6416 F1	TB 6416 F4	without lock	€42.70	65	€32.85
60 x40 x23.0	TB 6422 F1	TB 6422 F4	without lock	€46.19	45	€35.53
60 x40 x34.0	TB 6433 F1	TB 6433 F4	without lock	€55.23	30	€42.48
60 x40 x 17.5	TB S 6416 F1	TB S 6416 F4	with 1 lock	€62.48	65	€48.06
60 x40 x23.0	TB S 6422 F1	TB S 6422 F4	with 1 lock	€65.22	45	€50.17
60 x40 x34.0	TB S 6433 F1	TB S 6433 F4	with 1 lock	€70.83	30	€54.49

» Tool box model with lock not compatible with thermoformed inserts and dividers.



STANDARD COLOURS

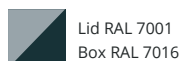
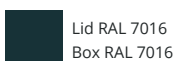

***) only for orders placed via the online shop. Dispatch only on working days, provided the goods are in stock.
Information regarding availability and current dispatch times can be found in the online shop.

Pallet prices apply only for full pallets. Prices exclusive VAT.

TOOL BOXES BASIC

AVAILABLE UP FROM 1 PIECE
no minimum purchase order.



READY FOR DISPATCH within **24** hours **

Simple convenience

AUER Packaging's basic tool box is a top-quality, versatile box which can be used to store and transport even bulky goods safely and conveniently. It is open at the top and has a correspondingly large capacity. The ergonomic handle guarantees an especially high level of carrying comfort, even for larger loads.

- Stackable when not coupled together
- Large capacity
- Rigid, ergonomic handle

TOOL BOXES BASIC

RAL 7016

Outer dimensions L x W x H (cm)	Article No.	Stacking height (cm)	Price for single unit	Units on pallet	Unit price on pallet
40 x30 x23	TB W 4316 F1	16.5	€18.51	120	€14.24
40 x30 x34	TB W 4327 F1	27.5	€27.92	70	€21.48



***) only for orders placed via the online shop. Dispatch only on working days, provided the goods are in stock. Information regarding availability and current dispatch times can be found in the online shop.

TOOL BOXES COOL BOX

AVAILABLE UP FROM 1 PIECE
no minimum purchase order.



READY FOR DISPATCH within **24** hours **

Cool stuff!

22-millimetre thick full insulation made from EPP foam turns the toolbox into a passive cool box. Simply insert ice packs, ice or even just cooled contents, and the box will keep everything cool for a long time. Extremely simple and no electrics required. The box can also be used to keep contents warm using the same principle.

- Passive cool/warm box
- Full insulation with 22-mm thick EPP foam
- Usable capacity: 20 litres
- No electrics required

TOOL BOXES COOL BOX

Outer dimensions L x W x H (cm)	Article No.	Article No.	Unit price on pallet	Units per pallet	Price for single unit
40 x30 x34	TB KB 4333 F1	TB KB 4333 F4	€50.66	60	€65.86

STANDARD COLOURS

 Lid RAL 7016
Box RAL 7016

 Lid RAL 7001
Box RAL 7016

***) only for orders placed via the online shop. Dispatch only on working days, provided the goods are in stock. Information regarding availability and current dispatch times can be found in the online shop.

Pallet prices apply only for full pallets. Prices exclusive VAT.

TOOLBOX WALL MOUNT 40 x 30 cm

AVAILABLE UP FROM 1 PIECE
no minimum purchase order.



READY FOR DISPATCH within **24 hours** **

Mounted on the wall or floor

Our wall- and floor-mounted toolboxes come with the same interlocking system that is used in all toolboxes. They enable the boxes to be quickly and securely mounted on the wall or floor, anywhere you desire.

- For toolbox mounting
- Horizontal or vertical installation
- Lightning-fast locking and unlocking capability

TOOLBOX WALL MOUNT 40 x 30 cm

For basic dimension L x W (cm)	Article No.	Article No.	Note	Unit price
40 x 30	TB WH 43-7001	TB WH 43-7016	Including mounting material for wall installation	€18.15
60 x 40	TB WH 64-7001	TB WH 64-7016	Including mounting material for wall installation	€23.43

STANDARD COLOURS

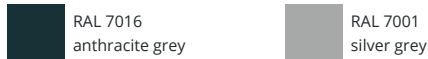

TOOL BOX TRANSPORT TROLLEYS

AVAILABLE UP FROM 1 PIECE
no minimum purchase order.

READY FOR DISPATCH within **24 hours** **



Coupled on wheels

The transport trolley for tool boxes by AUER Packaging is equipped with the innovative coupling system. It guarantees safe and effortless transport of tool boxes, even when boxes are stacked and the contents are heavy.

- Ergonomic
- Adapted for tool box series
- High load-bearing capacity
- Particularly smooth-running wheels

TOOL BOX TRANSPORT TROLLEYS

RAL 7016

Suitable for basic dimension	Article No.	Design	Price for single unit	Units on pallet	Unit price on pallet
40 x30	TB TR 43 FE	2 steering castors, 2 steering castors with wheel stop	€59.19	72	€45.53
40 x30	TB TR 43	Four steering castors	€59.04	72	€45.41
60 x40	TB TR 64 FE	2 steering castors, 2 steering castors with wheel stop	€70.23	36	€54.02
60 x40	TB TR 64	Four steering castors	€70.07	36	€53.90

***) only for orders placed via the online shop. Dispatch only on working days, provided the goods are in stock. Information regarding availability and current dispatch times can be found in the online shop.

HAND TROLLEY TOOL BOXES



AVAILABLE UP FROM 1 PIECE
no minimum purchase order.

Safely transported

The AUER Packaging hand trolley for tool boxes enables you to transport your products effortlessly from A to B, even on uneven ground. Its sturdy wheels and innovative coupling system guarantee safe transporting of tool boxes even when they are stacked.

- Ergonomic
- Adapted for tool box series
- High load-bearing capacity
- Suitable for rough ground

HAND TROLLEY TOOL BOXES

RAL 7016

Suitable for basic dimension	Article No.	Design	Carrying load	Price for single unit	Units on pallet	Unit price on pallet
40 x30	SK TB 43	without height adjustment	160 kg	€285.42	12	€219.56
40 x30	SK V TB 43	with height adjustment	160 kg	€316.93	12	€243.79
60 x40	SK TB 64	without height adjustment	160 kg	€290.88	9	€223.76
60 x40	SK V TB 64	with height adjustment	160 kg	€322.39	9	€247.99

TOOL BOXES RACK

AVAILABLE UP FROM 1 PIECE
no minimum purchase order.



Optimal stowage

AUER Packaging's tool box rack provides a flexible content loading facility in conjunction with suitable assortment boxes or drawers. The coupling system makes it possible to stack several racks securely, including in combination with tool boxes.

- Individually configurable
- Holds up to three assortment boxes or drawers 353
- Sets filled with high-quality tools available

TOOL BOXES RACK

Outer dimensions L x W x H (cm)	Article No.	Article No.	Loading	Price for single unit	Units on pallet	Unit price on pallet
40 x 30 x 34	TB RI 4333 F1	TB RI 4333 F4	unloaded	€41.77	60	€32.13

DRAWERS

RAL 7016

	Outer dimensions L x W x H (cm)	Article No.	Identification	Loading	Price for single unit	Units on pallet	Unit price on pallet
1	35 x 29.5 x 7.1	SB 353	Assortment boxes	Unloaded	€15.13	330	€11.64
2	35 x 29.5 x 7.1	SB 353 B1	Assortment boxes	Assembly 1	€30.47	330	€23.44
3	35 x 29.5 x 7.1	SB 353 B2	Assortment boxes	Assembly 2	€26.12	330	€20.09
4	35 x 29.5 x 7.1	SB 353 B3	Assortment boxes	Assembly 3	€25.36	330	€19.51
5	35 x 29.5 x 7.1	SB 353 B4	Assortment boxes	Assembly 4	€24.82	330	€19.09
6	35 x 29.5 x 7.1	SB 353 B5	Assortment boxes	Assembly 5	€21.86	330	€16.82
7	35 x 29.5 x 7.1	SB 353 B6	Assortment boxes	Assembly 6	€25.10	330	€19.31
8	35 x 29.5 x 7.1	SB 353 B7	Assortment boxes	Assembly 7	€24.71	330	€19.01
9	35 x 29.5 x 7.1	SB 353 B8	Assortment boxes	Assembly 8	€26.99	330	€20.76
10	35 x 29.5 x 7.1	SB 353 B9	Assortment boxes	Assembly 9	€22.61	330	€17.40
11	35 x 29.5 x 7.1	SB 353 B10	Assortment boxes	8 screwdrivers 1 x SB E 11 1 x SB E 12 1 x SB E 13	€101.03	330	€77.72
12	35 x 29.5 x 7.1	SB 353 B11	Assortment boxes	7 Torx screwdrivers 2 x SB E 23	€95.16	330	€73.20
13	35 x 29.5 x 7.1	SB 353 B12	Assortment boxes	4 pliers	€136.41	330	€104.93
14	35 x 29.5 x 7.1	SB 353 B13	Assortment boxes	8 double open-ended spanners	€105.99	330	€81.53
15	35 x 29.5 x 7.1	TB RS 43	Rack drawer	Unloaded	€5.37	105	€4.13
16	35 x 29.5 x 7.1	TB RS 43 B1	Rack drawer	8 screwdrivers 1 x SB E 11 1 x SB E 12 1 x SB E 13	€76.72	105	€59.02
17	35 x 29.5 x 7.1	TB RS 43 B2	Rack drawer	7 Torx screwdrivers 2 x SB E 23	€71.81	105	€55.24
18	35 x 29.5 x 7.1	TB RS 43 B3	Rack drawer	4 pliers	€106.36	105	€81.82
19	35 x 29.5 x 7.1	TB RS 43 B4	Rack drawer	8 double open-ended spanners	€81.01	105	€62.32





STANDARD COLOURS

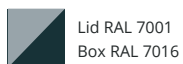
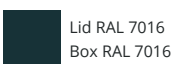

OUR TIP:

Configure and calculate the price of your individually filled toolbox rack online: www.auer-packaging.com/tbr

ACCESSORIES

for Tool boxes

Page 84 | Lid panels tool boxes

Page 84 | Deep-drawn tool box inserts

Page 78 | Transport trolleys

Page 87 | Tool carriers





Page 85 | foam-inlay lid nubbly



Page 85 | Tool box padding

Page 86 | Insert boxes Insert



TOOL BOX ACCESSORIES



DEEP-DRAWN TOOL BOX INSERTS 40 x 30 cm

RAL 7016

Article No.	Description	Price for single unit	Units on pallet	Unit price on pallet
1	TB TE 4324 Deep-drawn insert 24 compartments	€5.94	260	€4.57
2	TB TE 4312 Deep-drawn insert 12 compartments	€5.94	255	€4.57
3	TB TE 4306 Deep-drawn insert 6 compartments	€6.69	255	€5.15
4	TB TEV 43 Variable deep-drawn insert	€5.95	260	€4.57
	TB TEV TW Deep-drawn tool box inserts variable	€2.00	1000	€1.54

INSERTS FOR FOAM CANISTERS AND CARTRIDGES

Article No.	Outer dimensions L x W x H (cm)	Suitable for	Price for single unit	Units on pallet	Unit price on pallet
5	TB SESH 43 38.9 x 26.5 x 11.5	14 foam containers including spray pipe	€18.61	160	€14.31
6	TB SEKH 43 38.9 x 25.6 x 11.5	22 cartridges and 20 cartridge nozzles	€16.89	160	€12.99



LID PANELS TOOL BOXES 40 x 30 cm

Article No.	Suitable for	Price for single unit	Units on pallet	Unit price on pallet
7	TB DUS multi-purpose	€27.70	660	€21.31
8	TB DWS Tool	€18.29	1000	€14.07
9	TB DBS Office material	€18.77	2020	€14.44



TOOL BOX PADDING 40 x 30 cm

Article No.	Description	Price for single unit	Units per pallet	Unit price on pallet
10	TB SEDW 43 foam-inlay lid nubby	€15.51	400	€11.93
11	TB SERH 43 complete foam inlay	€19.97	700	€15.37
12	TB SESEH 43 intermediate plate	€7.92	800	€6.09
13	TB SEBW 43 foam-inlay bottom	€7.55	800	€5.81
14	TB SEBH 43 foam-inlay bottom	€6.26	2020	€4.82
15	TB SEWW 43 pre-cut foam	€3.87	800	€2.97
16	TB SEWH 43 pre-cut foam	€8.05	800	€6.20
17	TB SEDH 43 lid inlay EPP	€11.28	600	€8.68

TOOL BOX PADDING 60 x 40 cm

Article No.	Description	Price for single unit	Units per pallet	Unit price on pallet
10	TB SEDW 64 foam-inlay lid nubby	€17.02	200	€13.10
11	TB SERH 64 complete foam inlay	€30.54	350	€23.49
12	TB SESEH 64 intermediate plate	€11.80	400	€9.08
13	TB SEBW 64 foam-inlay bottom	€11.00	400	€8.46
14	TB SEBH 64 foam-inlay bottom	€8.25	1010	€6.35
15	TB SEWW 64 pre-cut foam	€4.43	400	€3.41
16	TB SEWH 64 pre-cut foam	€11.78	400	€9.06
17	TB SEDH 64 lid inlay EPP	€12.73	370	€9.80

TOOL BOX ACCESSORIES



INSERT BOXES INSERT

Article No.	Loading	Price for single unit
TB TEK 43	unloaded	€2.55
1 TB TEK 43 B1	Assembly 1: 33x SB E 11-6018	€13.72
2 TB TEK 43 B2	Assembly 2: 5x SB E 11-7001, 14x SB E 12-7001	€11.55
3 TB TEK 43 B3	Assembly 3: 5x SB E 11-7001, 7x SB E 14-6018	€11.73
4 TB TEK 43 B4	Assembly 4: 5x SB E 11-6018, 1x SB E 11-7001, 2x SB E 12-7001, 2x SB E 12-6018, 1x SB E 15-6018, 1x SB E 22-7001, 1x SB E 22-6018, 1x SB E 23-7001	€10.70
5 TB TEK 43 B5	Assembly 5: 4x SB E 11-7001, 1x SB E 11-6018, 2x SB E 12-7001, 1x SB E 14-7001, 1x SB E 22-6018, 1x SB E 23-6018, 1x SB E 25-6018	€10.10
6 TB TEK 43 B6	Assembly 6: 5x SB E 11-6018, 4x SB E 11-7001, 3x SB E 12-6018, 1x SB E 12-7001, 2x SB E 13-7001, 1x SB E 22-6018, 1x SB E 23-7001	€11.18
7 TB TEK 43 B7	Assembly 7: 1x SB E 11-7001, 3x SB E 14-6018, 2x SB E 25-7001	€9.64
8 TB TEK 43 B8	Assembly 8: 18x SB E 11-6018, 5x SB E 11-7001, 1x SB E 25-7001	€12.11
9 TB TEK 43 B9	Assembly 9: 5x SB E 11-6018, 1x SB E 12-6018, 7x SB E 12-7001, 1x SB E 26-6018	€10.53

OUR TIP: EQUIP THE INSERT YOURSELF!

Inserts are also available unassembled! Using the grid, they are easily and individually equipped with individual insert boxes. Insert boxes of various sizes and colours can be found on page 70 »

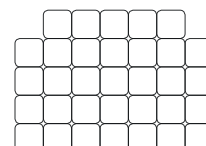

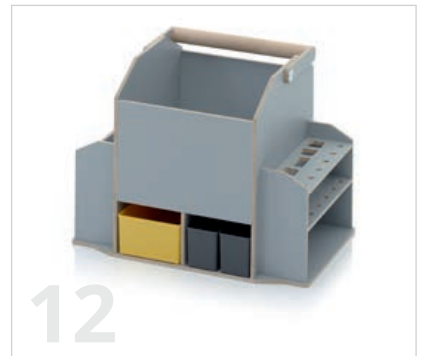
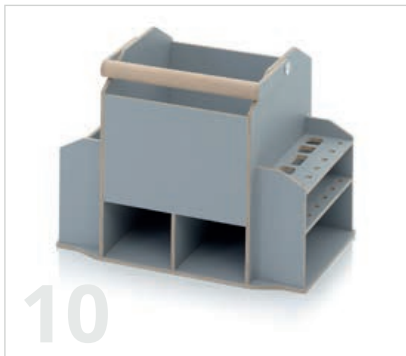

TOOL CARRIERS 40 x 30 cm

Article No.	Outer dimensions L x W x H (cm)	Loading	Price for single unit	Units on pallet	Unit price on pallet
10 TB WTE 43	38.9 x 26.5 x 29	unloaded	€228.74	40	€175.95
11 TB WTEG 43	38.9 x 26.5 x 29	unloaded	€343.69	40	€264.38
12 TB WTE 43 B	38.9 x 26.5 x 29	with insertable bins	€233.57	40	€179.67
13 TB WTEG 43 B	38.9 x 26.5 x 29	with Euro containers	€351.20	40	€270.15

ACCESSORIES OTHER

Article No.	Outer dimensions L x W x H (cm)	Description	Price for single unit	Units on pallet	Unit price on pallet
14 TB RS 43	35 x 29.5 x 7.1	Rack drawer	€5.37	105	€4.13
15 TB KES S		10 sheets of 3 rack drawer adhesive labels	€0.20		
16 TB KET S		10 sheets of 3 tool box adhesive labels each	€0.20		
17 TB SR 43		Lock retrofitted for Tool boxes 40 x 30 cm	€16.32		
TB SR 64		Lock retrofitted for Tool boxes 60 x 40 cm	€22.15		
18 TB OVG		Optional handle on the front	€3.20		
TB OSG		Optional handle on the side	€3.55		



PROTECTIVE CASES

Safe storage for sensitive items



PROTECTIVE CASES PRO

AVAILABLE UP FROM 1 PIECE
no minimum purchase order.

Seal

Pressure compensation
valve



Handle



Safe storage for sensitive items

The protective case by AUER Packaging protects sensitive contents, even under extreme conditions. Whether it's under water or at a dizzying height, its integrated pressure-equalising valve and robust structure means that the protective case withstands even the roughest conditions and the most extreme differences in temperature.

- Waterproof
- Stackable
- Especially robust
- Integrated pressure-equalisation valve

READY FOR DISPATCH within **24** hours **

PROTECTIVE CASES PRO UNLOADED

Outer dimensions L x W x H (cm)	Article No.	Article No.	Article No.	Price for single unit	Units per pallet	Unit price on pallet
30 x 20 x 14.05	CP 3213-2002	CP 3213-6003	CP 3213-7016	€35.13	147	€27.02
40 x 30 x 16.80	CP 4316-2002	CP 4316-6003	CP 4316-7016	€43.81	90	€33.70
40 x 30 x 22.30	CP 4322-2002	CP 4322-6003	CP 4322-7016	€45.82	72	€35.25
60 x 40 x 22.30	CP 6422-2002	CP 6422-6003	CP 6422-7016	€63.64	40	€48.96
60 x 40 x 27.80	CP 6427-2002	CP 6427-6003	CP 6427-7016	€66.87	30	€51.44
120 x 40 x 16.80	CP 12416-2002	CP 12416-6003	CP 12416-7016	€113.63	20	€87.41

Currently in certification procedure: IP67, UN, ATA300, STANAG 4280, Def Stan 81-41, IATA DGR, MIL-STD-810



***) only for orders placed via the online shop. Dispatch only on working days, provided the goods are in stock. Information regarding availability and current dispatch times can be found in the online shop.

PROTECTIVE CASES PRO TROLLEY

READY FOR DISPATCH
within **24 hours** **

AVAILABLE UP FROM 1 PIECE
no minimum purchase order.



The best protection on rollers

The protective case pro trolley from AUER Packaging features particularly impressive protection for sensitive goods, even in extreme conditions and is also very convenient: its integrated wheels and extending handle mean that the protective case can be moved effortlessly even when loaded with heavy contents.

- Waterproof
- Stackable
- Especially robust
- Integrated pressure-equalisation valve

PROTECTIVE CASES PRO TROLLEY UNLOADED

Outer dimensions L x W x H (cm)	Article No.	Article No.	Article No.	Price for single unit	Units per pallet	Unit price on pallet
45 x 40 x 22.3	CP 4422-2002	CP 4422-6003	CP 4422-7016	€138.36	50	€106.43
55 x 40 x 22.3	CP 5422-2002	CP 5422-6003	CP 5422-7016	€138.84	40	€106.80
60 x 40 x 33.3	CP 6433-2002	CP 6433-6003	CP 6433-7016	€145.11	25	€111.62
80 x 60 x 44.3	CP 8644-2002	CP 8644-6003	CP 8644-7016	€186.82	8	€143.71

Currently in certification procedure: IP67, UN, ATA300, STANAG 4280, Def Stan 81-41, IATA DGR, MIL-STD-810



STANDARD COLOURS

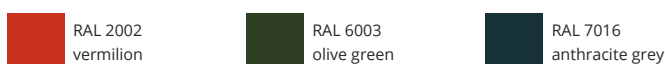

**) only for orders placed via the online shop. Dispatch only on working days, provided the goods are in stock. Information regarding availability and current dispatch times can be found in the online shop.

PROTECTIVE CASE LOADING



1 | PROTECTIVE CASES PRO DIE-CUT SOFT FOAM PADDING

Outer dimensions L x W x H (cm)	Article No.	Article No.	Article No.	Price for single unit	Units per pallet	Unit price on pallet
30 x 20 x 14.05	CP 3213 B1-2002	CP 3213 B1-6003	CP 3213 B1-7016	€56.76	147	€43.66
40 x 30 x 16.80	CP 4316 B1-2002	CP 4316 B1-6003	CP 4316 B1-7016	€74.02	90	€56.94
40 x 30 x 22.30	CP 4322 B1-2002	CP 4322 B1-6003	CP 4322 B1-7016	€90.29	72	€69.46
60 x 40 x 22.30	CP 6422 B1-2002	CP 6422 B1-6003	CP 6422 B1-7016	€110.17	40	€84.75
60 x 40 x 27.80	CP 6427 B1-2002	CP 6427 B1-6003	CP 6427 B1-7016	€121.93	30	€93.79



2 | PROTECTIVE CASES PRO ALL-ROUND PADDING

Outer dimensions L x W x H (cm)	Article No.	Article No.	Article No.	Price for single unit	Units per pallet	Unit price on pallet
30 x 20 x 14.05	CP 3213 B2-2002	CP 3213 B2-6003	CP 3213 B2-7016	€53.08	147	€40.83
40 x 30 x 16.80	CP 4316 B2-2002	CP 4316 B2-6003	CP 4316 B2-7016	€64.28	90	€49.45
40 x 30 x 22.30	CP 4322 B2-2002	CP 4322 B2-6003	CP 4322 B2-7016	€70.51	72	€54.24
60 x 40 x 22.30	CP 6422 B2-2002	CP 6422 B2-6003	CP 6422 B2-7016	€97.36	40	€74.89
60 x 40 x 27.80	CP 6427 B2-2002	CP 6427 B2-6003	CP 6427 B2-7016	€106.73	30	€82.10



3 | PROTECTIVE CASES PRO ALL-ROUND PADDING WITH PARTITIONS

Outer dimensions L x W x H (cm)	Article No.	Article No.	Article No.	Price for single unit	Units per pallet	Unit price on pallet
40 x 30 x 16.80	CP 4316 B3-2002	CP 4316 B3-6003	CP 4316 B3-7016	€74.25	90	€57.11
40 x 30 x 22.30	CP 4322 B3-2002	CP 4322 B3-6003	CP 4322 B3-7016	€87.44	72	€67.26
60 x 40 x 22.30	CP 6422 B3-2002	CP 6422 B3-6003	CP 6422 B3-7016	€113.50	40	€87.31
60 x 40 x 27.80	CP 6427 B3-2002	CP 6427 B3-6003	CP 6427 B3-7016	€124.80	30	€96.00



4 | PROTECTIVE CASES PRO GROOVED FOAM PADDING

Outer dimensions L x W x H (cm)	Article No.	Article No.	Article No.	Price for single unit	Units per pallet	Unit price on pallet
30 x 20 x 14.05	CP 3213 B4-2002	CP 3213 B4-6003	CP 3213 B4-7016	€55.45	147	€42.66
40 x 30 x 16.80	CP 4316 B4-2002	CP 4316 B4-6003	CP 4316 B4-7016	€71.98	90	€55.37
40 x 30 x 22.30	CP 4322 B4-2002	CP 4322 B4-6003	CP 4322 B4-7016	€86.30	72	€66.38
60 x 40 x 22.30	CP 6422 B6-2002	CP 6422 B6-6003	CP 6422 B6-7016	€111.09	40	€85.45
60 x 40 x 27.80	CP 6427 B6-2002	CP 6427 B6-6003	CP 6427 B6-7016	€122.85	30	€94.50
80 x 60 x 44.3	CP 8644 B3-2002 *	CP 8644 B3-6003 *	CP 8644 B3-7016 *	€333.36	8	€256.43
120 x 40 x 16.80	CP 12416 B3-2002	CP 12416 B3-6003	CP 12416 B3-7016	€196.91	20	€151.47

* Trolley



5 | PROTECTIVE CASES PRO PADDED INLAY T

Outer dimensions L x W x H (cm)	Article No.	Article No.	Article No.	Price for single unit	Units per pallet	Unit price on pallet
60 x 40 x 22.30	CP 6422 B5-2002	CP 6422 B5-6003	CP 6422 B5-7016	€230.25	40	€177.12
60 x 40 x 27.80	CP 6427 B5-2002	CP 6427 B5-6003	CP 6427 B5-7016	€227.66	30	€175.12



6 | PROTECTIVE CASES PRO PADDED INLAY

Outer dimensions L x W x H (cm)	Article No.	Article No.	Article No.	Price for single unit	Units per pallet	Unit price on pallet
60 x 40 x 22.30	CP 6422 B4-2002	CP 6422 B4-6003	CP 6422 B4-7016	€225.16	40	€173.20
60 x 40 x 27.80	CP 6427 B4-2002	CP 6427 B4-6003	CP 6427 B4-7016	€225.89	30	€173.76



7 | PROTECTIVE CASES PRO TROLLEY COMPARTMENT INSERT (OFFICE INSERT BELT GREY)

Outer dimensions L x W x H (cm)	Article No.	Article No.	Article No.	Price for single unit	Units per pallet	Unit price on pallet
45 x 40 x 22.3	CP 4422 B2-2002	CP 4422 B2-6003	CP 4422 B2-7016	€292.60	50	€225.08



8 | PROTECTIVE CASES PRO TROLLEY LAPTOP INSERT 13" WITH LID PANEL BELT GREY

Outer dimensions L x W x H (cm)	Article No.	Article No.	Article No.	Price for single unit	Units per pallet	Unit price on pallet
45 x 40 x 22.3	CP 4422 B3-2002	CP 4422 B3-6003	CP 4422 B3-7016	€355.21	50	€273.24



9 | PROTECTIVE CASES PRO TROLLEY LAPTOP INSERT 15" WITH LID PANEL BELT GREY

Outer dimensions L x W x H (cm)	Article No.	Article No.	Article No.	Price for single unit	Units per pallet	Unit price on pallet
55 x 40 x 22.3	CP 5422 B2-2002	CP 5422 B2-6003	CP 5422 B2-7016	€385.86	40	€296.82



STANDARD COLOURS



RAL 2002
vermilion



RAL 6003
olive green

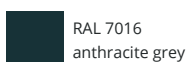

RAL 7016
anthracite grey

PROTECTIVE CASE ACCESSORIES

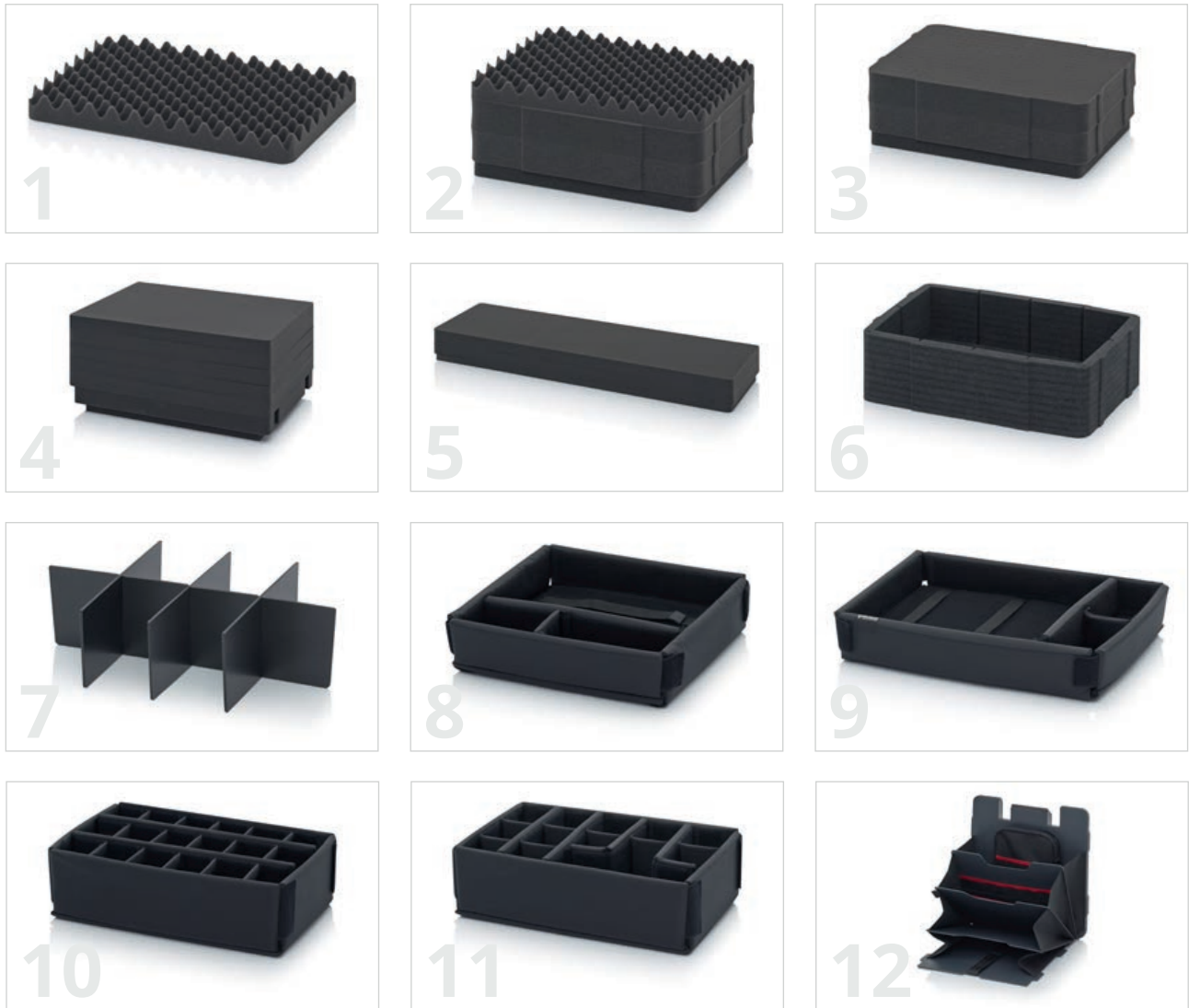

1 | LID PADDING SUITABLE FOR PROTECTIVE CASES

Article No.	Suitable for	Colour	Price for single unit
CP SEDNW 32	Protective case 30 x 20 cm	anthracite grey	€4.10
CP SEDNW 43	Protective case 40 x 30 cm	anthracite grey	€5.27
CP SEDNW 44	Protective case 40 x 40 cm	anthracite grey	€9.46
CP SEDNW 54	Protective case 50 x 40 cm	anthracite grey	€13.79
CP SEDNW 64	Protective case 60 x 40 cm	anthracite grey	€9.95
CP SEDNW 86	Protective case 80 x 60 cm	anthracite grey	€16.48
CP SEDNW 124	Protective case 120 x 40 cm	anthracite grey	€25.21

2 | GROOVED FOAM PADDING PROTECTIVE CASE

Article No.	Suitable for	Colour	Price for single unit
CP S SEBNW 3213	Protective case 30 x 20 cm	anthracite grey	€8.03
CP S SEBNW 4316	Protective case 40 x 30 cm	anthracite grey	€14.51
CP S SEBNW 4322	Protective case CP 4322	anthracite grey	€26.05
CP S SEBNW 4422	Protective case 40 x 40 cm	anthracite grey	€25.06
CP S SEBNW 5422	Protective case 50 x 40 cm	anthracite grey	€29.19
CP S SEBNW 6422	Protective case 60 x 40 cm	anthracite grey	€27.61
CP S SEBNW 6427	Protective case CP 6427	anthracite grey	€35.78
CP S SEBNW 6433	Protective case CP 6433	anthracite grey	€54.89
CP S SEBNW 8644	Protective case 80 x 60 cm	anthracite grey	€113.98
CP S SEBNW 12416	Protective case 120 x 40 cm	anthracite grey	€45.94

3 | CUBED FOAM PAD SUITABLE FOR PROTECTIVE CASES

Article No.	Suitable for	Colour	Price for single unit
CP S SEWW 3213	Protective case 30 x 20 cm	anthracite grey	€9.26
CP S SEWW 4316	Protective case 40 x 30 cm	anthracite grey	€16.42
CP S SEWW 4322	Protective case CP 4322	anthracite grey	€29.80
CP S SEWW 4422	Protective case 40 x 40 cm	anthracite grey	€26.13
CP S SEWW 5422	Protective case 50 x 40 cm	anthracite grey	€31.49
CP S SEWW 6422	Protective case 60 x 40 cm	anthracite grey	€27.98
CP S SEWW 6427	Protective case CP 6427	anthracite grey	€36.56
CP S SEWW 6433	Protective case CP 6433	anthracite grey	€55.67

FOAM INSERT SOFT FOAM SUITABLE FOR PROTECTIVE CASES

Article No.	Suitable for	Colour	Price for single unit
4 CP S SEW 8644	Protective case 80 x 60 cm	anthracite grey	€109.79
5 CP S SEW 12416	Protective case 120 x 40 cm	anthracite grey	€48.03

6 | ALL-ROUND PADDING SUITABLE FOR PROTECTIVE CASES

Article No.	Suitable for	Colour	Price for single unit
CP SERP 3213	Protective case 30 x 20 cm	black	€5.81
CP SERP 4316	Protective case 40 x 30 cm	black	€7.29
CP SERP 4322	Protective case CP 4322	black	€11.25
CP SERP 6422	Protective case 60 x 40 cm	black	€14.74
CP SERP 6427/6433	Protective case CP 6427	black	€20.49
CP SERP 6433	Protective case CP 6433	black	€29.35

7 | PARTITIONS SUITABLE FOR PROTECTIVE CASES WITH ALL-ROUND PADDING

Article No.	Suitable for	Colour	Price for single unit
CP SERPG 3213	Protective case 30 x 20 cm	black	€3.71
CP SERPG 4316	Protective case 40 x 30 cm	black	€9.34
CP SERPG 4322	Protective case CP 4322	black	€15.87
CP SERPG 6422	Protective case 60 x 40 cm	black	€15.13
CP SERPG 6427	Protective case CP 6427	black	€16.95

PADDING SUITABLE FOR PROTECTIVE CASES

Article No.	Suitable for	Description	Colour	Price for single unit
8 CP PE 4422	CP 4422, CP S 4422	Laptop insert for laptops up to 13"	black	€68.84
9 CP PE 5422	CP 5422, CP S 5422	Laptop insert for laptops up to 15"	black	€77.90
10 CP PET 6422	CP 6422, CP S 6422	with 2 longitudinal dividers, 15 intermediate dividers	black	€134.55
11 CP PETK 6422	CP 6422, CP S 6422	with 2 transverse dividers and 2 folding transverse dividers, 8 intermediate dividers	black	€139.33
CP PET 6427/6433	CP 6427, CP 6433, CP S 6427, CP S 6433	with 2 longitudinal dividers, 15 intermediate dividers	black	€132.21
CP PETK 6427/6433	CP 6427, CP 6433, CP S 6427, CP S 6433	with 2 transverse dividers and 2 folding transverse dividers, 8 intermediate dividers	black	€133.87

LID PANEL SUITABLE FOR PROTECTIVE CASES

Article No.	Article No.	Suitable for	Design	Price for single unit
CP DT 4422 R	CP DT 4422 G	CP 4422, CP S 4422	Office insert	€90.57
CP DT 5422 R	CP DT 5422 G	CP 5422, CP S 5422	Office insert	€134.49
12 CP FE 4422 R	CP FE 4422 G	CP 4422, CP S 4422	Compartment insert (office insert)	€127.88



SPACE-SAVING CONTAINERS

Versatile storage aids



REUSABLE CONTAINERS

AVAILABLE UP FROM 1 PIECE
no minimum purchase order.

SPECIAL COLOURS
Simply order online



product
design
award

2013

READY FOR DISPATCH **24** hours**
within

Versatile storage aids

AUER Packaging's reusable containers are an especially versatile storage aid. Due to their slightly conical shape, they can be stacked inside each other when empty or stacked on top of each other using lids or stacking frames.

- Up to 75% less empty volume
- Space-saving when transported empty
- Can be stacked inside and on top of each other
- Especially sturdy

***) only for orders placed via the online shop. Dispatch only on working days, provided the goods are in stock. Information regarding availability and current dispatch times can be found in the online shop.



REUSABLE CONTAINERS CLASSIC

RAL 5015

Outer dimensions L x W x H (cm)	Article No.	Price for single unit	Units on pallet	Unit price on pallet
30 x 20 x 17	MB 3217	€3.11	800	€2.40
40 x 30 x 22	MB 4322	€5.31	400	€4.09
40 x 30 x 27	MB 4327	€6.26	300	€4.82
40 x 30 x 32	MB 4332	€7.14	240	€5.49
60 x 40 x 17	MB 6417	€8.17	200	€6.28
60 x 40 x 22	MB 6422	€9.20	200	€7.08
60 x 40 x 27	MB 6427	€10.81	150	€8.31
60 x 40 x 32	MB 6432	€12.36	120	€9.51
60 x 40 x 42	MB 6442	€15.42	90	€11.86
80 x 60 x 32	MB 8632	€28.50	48	€21.92
80 x 60 x 42	MB 8632K	€40.23	30	€30.95
80 x 60 x 42	MB 8642	€33.65	36	€25.88
80 x 60 x 52	MB 8642K	€45.30	28	€34.84



REUSABLE CONTAINERS WITH LID

RAL 5015

Outer dimensions L x W x H (cm)	Article No.	Price for single unit	Units on pallet	Unit price on pallet
30 x 20 x 19	MBD 3217	€5.92	300	€4.56
40 x 30 x 24	MBD 4322	€9.50	168	€7.31
40 x 30 x 29	MBD 4327	€10.46	138	€8.04
40 x 30 x 34	MBD 4332	€11.35	114	€8.73
60 x 40 x 19	MBD 6417	€14.61	112	€11.24
60 x 40 x 24	MBD 6422	€15.65	112	€12.04
60 x 40 x 29	MBD 6427	€17.26	92	€13.28
60 x 40 x 34	MBD 6432	€18.85	76	€14.50
60 x 40 x 44	MBD 6442	€21.95	60	€16.89
80 x 60 x 34	MBD 8632	€42.13	38	€32.40
80 x 60 x 44	MBD 8632K	€55.76	30	€42.89
80 x 60 x 44	MBD 8642	€47.28	30	€36.37
80 x 60 x 54	MBD 8642K	€60.82	28	€46.79



REUSABLE CONTAINERS WITH STACKING FRAME

RAL 5015

Outer dimensions L x W x H (cm)	Article No.	Price for single unit	Units on pallet	Unit price on pallet
30 x 20 x 17	MBB 3217	€4.46	560	€3.43
40 x 30 x 22	MBB 4322	€6.81	400	€5.24
40 x 30 x 27	MBB 4327	€7.76	300	€5.97
40 x 30 x 32	MBB 4332	€8.64	240	€6.64
60 x 40 x 17	MBB 6417	€10.18	200	€7.83
60 x 40 x 22	MBB 6422	€11.22	200	€8.63
60 x 40 x 27	MBB 6427	€12.82	150	€9.86
60 x 40 x 32	MBB 6432	€14.43	120	€11.10
60 x 40 x 42	MBB 6442	€17.49	90	€13.45
80 x 60 x 32	MBB 8632	€39.54	38	€30.42
80 x 60 x 42	MBB 8632K	€53.23	30	€40.95
80 x 60 x 42	MBB 8642	€44.70	30	€34.38
80 x 60 x 52	MBB 8642K	€58.29	28	€44.84



ACCESSORIES REUSABLE CONTAINERS

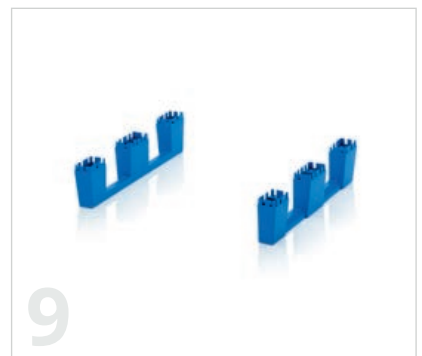

OUR TIP: SIMPLE SELF-ASSEMBLY

Our accessories are suitable for self-assembly and can be attached to the products in just a few steps. All the assembly materials you need – such as screws – are included.

Our customer service will gladly assist you:

info@auer-packaging.com

HINGED LIDS FOR REUSABLE CONTAINERS FOR SELF-ASSEMBLY

RAL 5015

	Suitable for basic dimension	Article No.	Made up of	Price for single unit	Units on pallet	Unit price on pallet
1	30 x20	MB DE 32	1 two-piece hinged lid, 4 hinges	€2.52	900	€1.94
2	40 x30	MB DE 43	1 two-piece hinged lid, 4 hinges	€4.91	460	€3.78
3	60 x40	MB DE 64	1 two-piece hinged lid, 6 hinges	€5.76	200	€4.43
4	80 x60	MB DE 86	1 two-piece hinged lid, 8 hinges	€12.80	100	€9.84



STACKING FRAMES FOR SELF-ASSEMBLY

RAL 9017

	Suitable for basic dimension	Article No.	Price for single unit	Units on pallet	Unit price on pallet
5	30 x20	MB SB 32	€2.41	400	€1.85
6	40 x30	MB SB 43	€4.89	400	€3.76
7	60 x40	MB SB 64	€5.46	200	€4.20
8	80 x60	MB SBSC 86	€20.06	100	€15.43

SKID SET FOR SELF-ASSEMBLY

RAL 5015

	Suitable for basic dimension	Article No.	Made up of	Price for single unit	Units on pallet	Unit price on pallet
9	80 x60	MB KU	2 skids, 24 thermoplastic screws	€9.82	50	€7.56



WHEELS FOR REUSABLE CONTAINERS

	Suitable for basic dimension	Article No.	Made up of	Unit price
10	80 x60	MBRA	4 polyamide wheels (ø 125 mm), 16 thermoplastic screws	€44.27



SEAL

RAL 9017

	Article No.	Tensile load-bearing capacity	Price for single unit	Units on pallet	Unit price on pallet
11	PB	approx. 20 N	€0.28	125000	€0.21



OUR TIP: SEALING WITH PLUG-IN SEALS

Plug-in seals are used to seal transport containers. If the container has been opened, the seal at the predetermined break point is destroyed, which is an indication that something about the contents might have changed. Plug-in seals are suitable for reusable containers, IBC containers and folding boxes.

12 | SELF-ADHESIVE BAGS

	Article No.	Design	Unit price
	7034	self-adhesive pocket A6 crosswise	€0.29
	7035	self-adhesive pocket A5 crosswise	€0.38
	7036	self-adhesive pocket A4 crosswise	€0.57



FOLDABLE BOXES

AVAILABLE UP FROM 1 PIECE
no minimum purchase order.

SPECIAL COLOURS
Simply order online

READY FOR DISPATCH **24** hours**
within



Space saving made easy

AUER Packaging's foldable box combines impressive functionality and ease of use. In a few quick steps, you can fold it up and save up to 82% of the space taken up by a normal plastic container. The optional lid provides additional protection for the contents.

» Find ESD version on page 218

- Secure, quick folding
- Up to 82% reduction in volume
- Ideal transportation and picking box
- Sturdy folding mechanism

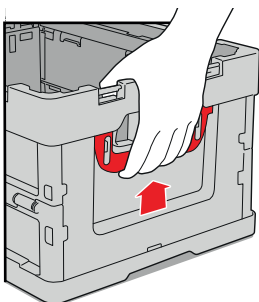

DID YOU KNOW?

Our folding boxes can be folded very quickly. Simply pull the red control elements on the sides upwards and push the outer wall slightly inwards. The automatic folding mechanism ensures that the box is reduced to a minimum of its actual size.

***) only for orders placed via the online shop. Dispatch only on working days, provided the goods are in stock. Information regarding availability and current dispatch times can be found in the online shop.



FOLDABLE BOXES WITHOUT LID

RAL 7001

Outer dimensions L x W x H (cm)	Article No.	Price for single unit	Units on pallet	Unit price on pallet
40 x 30 x 22.0	FB 43/22	€13.13	280	€10.10
40 x 30 x 27.0	FB 43/27	€14.57	220	€11.20
40 x 30 x 32.0	FB 43/32	€15.58	220	€11.98
60 x 40 x 22.0	FB 64/22	€17.59	140	€13.53
60 x 40 x 27.0	FB 64/27	€18.93	140	€14.57
60 x 40 x 32.0	FB 64/32	€20.17	140	€15.52
60 x 40 x 42.0	FB 64/42	€23.54	110	€18.11
80 x 60 x 44.5	FB 86/445	€44.13	40	€33.95



FOLDABLE BOXES WITH LID

RAL 7001

Outer dimensions L x W x H (cm)	Article No.	Price for single unit	Units on pallet	Unit price on pallet
40 x 30 x 22.0	FBD 43/22	€15.37	280	€11.82
40 x 30 x 27.0	FBD 43/27	€16.80	220	€12.92
40 x 30 x 32.0	FBD 43/32	€17.81	220	€13.70
60 x 40 x 22.0	FBD 64/22	€21.54	140	€16.57
60 x 40 x 27.0	FBD 64/27	€22.88	140	€17.60
60 x 40 x 32.0	FBD 64/32	€24.12	140	€18.55
60 x 40 x 42.0	FBD 64/42	€27.49	110	€21.15
80 x 60 x 44.5	FBD 86/445	€52.87	40	€40.67



HINGED LIDS FOR FOLDABLE BOXES FOR SELF-ASSEMBLY

RAL 7001

Suitable for basic dimension	Article No.	Price for single unit	Units on pallet	Unit price on pallet
40 x 30	FB DE 43	€2.15	800	€1.66
60 x 40	FB DE 64	€3.88	440	€2.99
80 x 60	FB DE 86	€8.84	75	€6.80



SEAL

RAL 9017

Article No.	Tensile load-bearing capacity	Price for single unit	Units on pallet	Unit price on pallet
PB	approx. 20 N	€0.28	125000	€0.21



OUR TIP: SEALING WITH PLUG-IN SEALS

Plug-in seals are used to seal transport containers. If the container has been opened, the seal at the predetermined break point is destroyed, which is an indication that something about the contents might have changed. Plug-in seals are suitable for reusable containers, IBC containers and folding boxes.

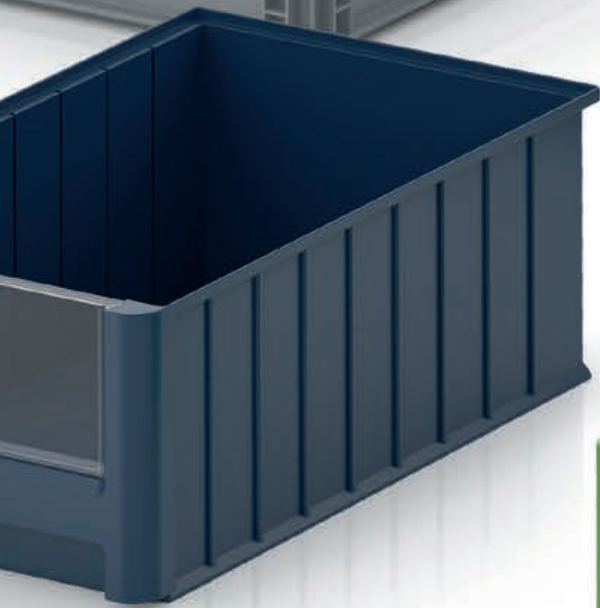

STORAGE BOXES WITH OPEN FRONT

Be up-to-date with small components



STORAGE BOXES WITH OPEN FRONT SK

READY FOR DISPATCH within **24 hours**

AVAILABLE UP FROM 1 PIECE
no minimum purchase order.

SPECIAL COLOURS
Simply order online

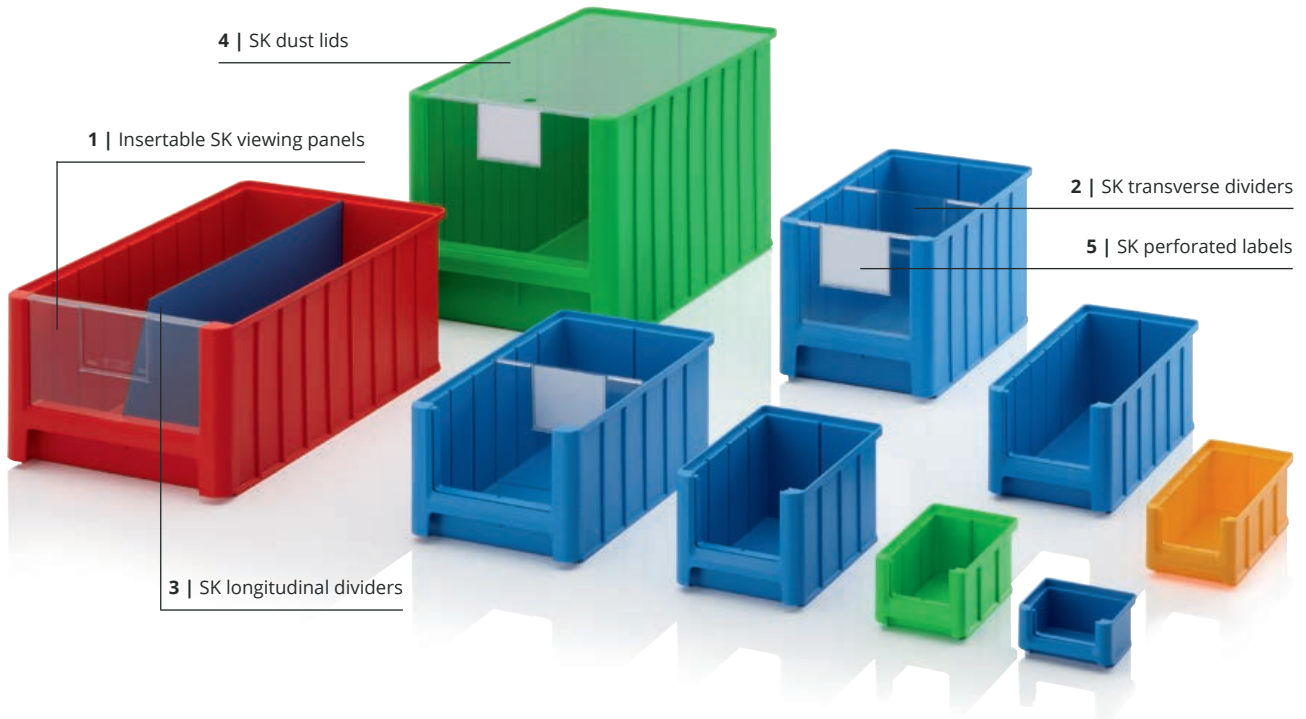

The next generation

The outstanding feature of AUER Packaging's SK storage box with open front is its superb flexibility and functionality. It can be subdivided using various inserts, and it can be provided with viewing panels as well as a dust lid. The new generation of storage boxes with open front is available as standard in nine different sizes and five colours.

- Facilitates your work processes
- Very stable design
- Plenty of space for contents
- Stackable

STORAGE BOXES WITH OPEN FRONT SK

Outer dimensions L x W x H (cm)	Article No.	Article No.	Article No.	Article No.	Article No.	Price for single unit	Units on pallet	Unit price on pallet
8.5 x 10.2 x 5.0	SK 1-1028	SK 1-3020	SK 1-5015	SK 1-6018	SK 1-7016	€0.39	6150	€0.30
16.0 x 10.2 x 7.5	SK 2-1028	SK 2-3020	SK 2-5015	SK 2-6018	SK 2-7016	€0.89	2000	€0.68
22.0 x 10.2 x 7.5	SK 2L-1028	SK 2L-3020	SK 2L-5015	SK 2L-6018	SK 2L-7016	€1.10	1240	€0.84
22.5 x 15.0 x 12.5	SK 3-1028	SK 3-3020	SK 3-5015	SK 3-6018	SK 3-7016	€1.90	576	€1.47
32.5 x 15.0 x 12.5	SK 3L-1028	SK 3L-3020	SK 3L-5015	SK 3L-6018	SK 3L-7016	€2.52	378	€1.94
35.0 x 21.0 x 15.0	SK 4-1028	SK 4-3020	SK 4-5015	SK 4-6018	SK 4-7016	€3.81	210	€2.93
35.0 x 21.0 x 20.0	SK 4H-1028	SK 4H-3020	SK 4H-5015	SK 4H-6018	SK 4H-7016	€4.84	154	€3.73
50.0 x 31.0 x 20.0	SK 5-1028	SK 5-3020	SK 5-5015	SK 5-6018	SK 5-7016	€7.31	77	€5.62
50.0 x 31.0 x 30.0	SK 5H-1028	SK 5H-3020	SK 5H-5015	SK 5H-6018	SK 5H-7016	€10.22	49	€7.86



STANDARD COLOURS

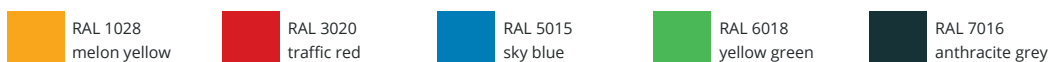

***) only for orders placed via the online shop. Dispatch only on working days, provided the goods are in stock. Information regarding availability and current dispatch times can be found in the online shop.

ACCESSORIES SK STORAGE BOXES WITH OPEN FRONT

1 | INSERTABLE SK VIEWING PANELS

transparent

Article No.	Suitable for	Price for single unit	Units on pallet	Unit price on pallet
ES 1	SK 1	€0.31	73600	€0.24
ES 2	SK 2, SK 2L	€0.33	37760	€0.26
ES 3	SK 3, SK 3L	€0.39	14400	€0.30
ES 4	SK 4	€0.69	7680	€0.53
ES 4H	SK 4H	€0.70	8400	€0.54
ES 5	SK 5	€1.40	3840	€1.08
ES 5H	SK 5H	€1.56	3360	€1.20



- Provides protection from damage and dirt
- With label field
- Made of transparent plastic

2 | SK TRANSVERSE DIVIDERS

transparent

Article No.	Suitable for	Price for single unit	Units on pallet	Unit price on pallet
QT 2	SK 2, SK 2L	€0.35	23040	€0.27
QT 3	SK 3, SK 3L	€0.45	7680	€0.35
QT 4	SK 4	€0.70	6000	€0.54
QT 4H	SK 4H	€0.88	5040	€0.68
QT 5	SK 5	€1.54	3600	€1.19
QT 5H	SK 5H	€2.21	1920	€1.70



- With label field
- Made of transparent plastic
- Adjustable in 50 mm increments
- Provides firm grip

3 | SK LONGITUDINAL DIVIDERS

RAL 5015

Article No.	Suitable for	Price for single unit	Units on pallet	Unit price on pallet
LT 2	SK 2	€2.16	1000	€1.67
LT 2L	SK 2L	€2.44	1000	€1.88
LT 3	SK 3	€3.14	1000	€2.42
LT 3L	SK 3L	€3.92	1000	€3.02
LT 4	SK 4	€5.48	1000	€4.22
LT 4H	SK 4H	€7.22	1000	€5.55
LT 5	SK 5	€9.11	1000	€7.01
LT 5H	SK 5H	€12.71	1000	€9.78

- For dividing lengthwise
- Better overview
- Made of blue-coated special plastic

4 | SK DUST LIDS

transparent

Article No.	Suitable for	Price for single unit	Units on pallet	Unit price on pallet
SD 1	SK 1	€1.78	1000	€1.37
SD 2	SK 2	€2.07	1000	€1.59
SD 2L	SK 2L	€2.56	1000	€1.97
SD 3	SK 3	€3.14	1000	€2.42
SD 3L	SK 3L	€3.34	1000	€2.57
SD 4	SK 4, SK 4H	€3.63	1000	€2.79
SD 5	SK 5, SK 5H	€4.56	1000	€3.51



- Provides protection from damage and dirt
- With grab hole for easier removal
- Made of clear Plexiglas

5 | SK PERFORATED LABELS

RAL 9016

Article No.	Suitable for	Number of labels per pack	1 - 9 per unit	starting at 10 per unit
PE SK 1	SK 1	900	€27.34	€21.03
PE SK 2	SK 2, SK 2L	450	€27.34	€21.03
PE SK 3	SK 3, SK 3L	150	€27.34	€21.03
PE SK 4	SK 4, SK 4H	150	€27.34	€21.03
PE SK 5	SK 5, SK 5H	150	€27.34	€21.03

- Perforated labels
- 140 g/sqm
- Suitable for inkjet and laser printing

RACK BOXES AND MATERIAL FLOW BOXES

AVAILABLE UP FROM 1 PIECE
no minimum purchase order.

SPECIAL COLOURS
Simply order online

READY FOR DISPATCH within **24** hours**

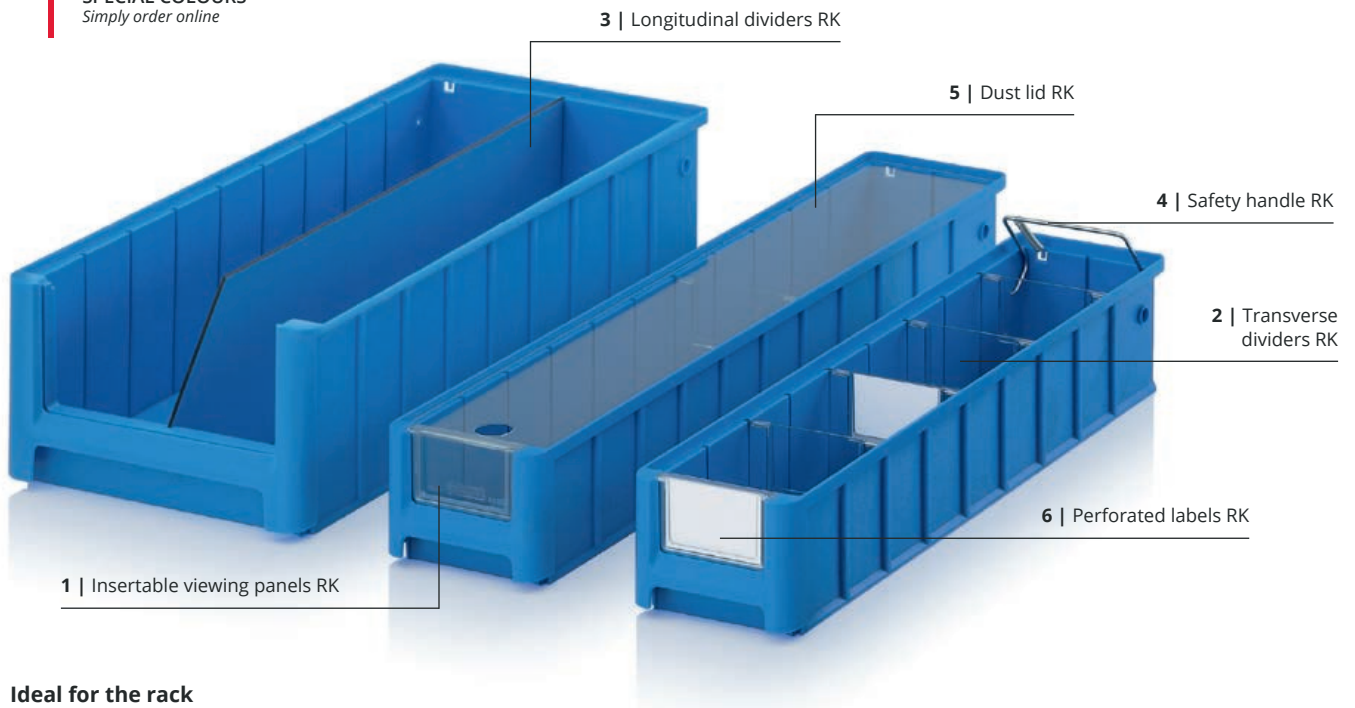

Ideal for the rack

AUER Packaging's rack and material flow box fits easily into the AUER system trolley and is available for rack depths of 30 cm to 60 cm. Additional viewing panels, transverse and longitudinal dividers, dust lids and labels help you to keep track of things perfectly.

- Facilitates your work processes
- Very stable design
- Plenty of space for contents
- Stackable

RACK BOXES AND MATERIAL FLOW BOXES

RAL 5015

Outer dimensions L x W x H (cm)	Article No.	For shelf depth (cm)	Viewing/access opening W x H (cm)	Price for single unit	Units on pallet	Unit price on pallet
30 x 11.7 x 9	RK 3109	30	7.6 x 4.7	€2.18	832	€1.67
30 x 15.6 x 9	RK 31509	30	10.7 x 4.7	€2.24	624	€1.73
30 x 23.4 x 9	RK 3209	30	17.6 x 4.7	€2.75	416	€2.12
30 x 23.4 x 14	RK 3214	30	17.6 x 8.7	€3.40	256	€2.62
40 x 11.7 x 9	RK 4109	40	7.6 x 4.7	€2.41	624	€1.85
40 x 15.6 x 9	RK 41509	40	10.7 x 4.7	€2.60	468	€2.00
40 x 23.4 x 9	RK 4209	40	17.6 x 4.7	€3.08	312	€2.37
40 x 23.4 x 14	RK 4214	40	17.6 x 8.7	€3.82	192	€2.94
50 x 11.7 x 9	RK 5109	50	7.6 x 4.7	€2.87	520	€2.21
50 x 15.6 x 9	RK 51509	50	10.7 x 4.7	€3.10	364	€2.39
50 x 23.4 x 9	RK 5209	50	17.6 x 4.7	€3.67	260	€2.82
50 x 23.4 x 14	RK 5214	50	17.6 x 8.7	€4.54	160	€3.49
60 x 11.7 x 9	RK 6109	60	7.6 x 4.7	€3.57	416	€2.75
60 x 15.6 x 9	RK 61509	60	10.7 x 4.7	€3.89	312	€2.99
60 x 23.4 x 9	RK 6209	60	17.6 x 4.7	€4.50	208	€3.46
60 x 23.4 x 14	RK 6214	60	17.6 x 8.7	€5.27	128	€4.05



***) only for orders placed via the online shop. Dispatch only on working days, provided the goods are in stock. Information regarding availability and current dispatch times can be found in the online shop.

ACCESSORIES RACK BOXES AND MATERIAL FLOW BOXES

1 | INSERTABLE VIEWING PANELS RK

transparent

Article No.	Suitable for	Price for single unit	Units on pallet	Unit price on pallet
ES 109	RK 3109, RK 4109, RK 5109, RK 6109	€0.46	34560	€0.35
ES 1509	RK 31509, RK 41509, RK 51509, RK 61509	€0.34	19200	€0.26
ES 209	RK 3209, RK 4209, RK 5209, RK 6209	€0.51	14400	€0.39
ES 214	RK 3214, RK 4214, RK 5214, RK 6214	€0.64	7200	€0.50

- Provides protection from damage and dirt
- With label field
- Made of transparent plastic

2 | TRANSVERSE DIVIDERS RK

transparent

Article No.	Suitable for	Price for single unit	Units on pallet	Unit price on pallet
QT 109	RK 3109, RK 4109, RK 5109, RK 6109	€0.50	21600	€0.38
QT 1509	RK 31509, RK 41509, RK 51509, RK 61509	€0.59	15360	€0.46
QT 209	RK 3209, RK 4209, RK 5209, RK 6209	€0.64	8640	€0.50
QT 214	RK 3214, RK 4214, RK 5214, RK 6214	€0.86	6480	€0.66

- With label field
- Made of transparent plastic
- Adjustable in 50 mm increments
- Provides firm grip

3 | LONGITUDINAL DIVIDERS RK

RAL 5015

Article No.	Suitable for	Price for single unit	Units on pallet	Unit price on pallet
LT 309	RK 3109, RK 31509, RK 3209	€3.30	1000	€2.54
LT 314	RK 3214	€4.27	1000	€3.29
LT 409	RK 4109, RK 41509, RK 4209	€4.43	1000	€3.41
LT 414	RK 4214	€5.75	1000	€4.43
LT 509	RK 5109, RK 51509, RK 5209	€5.58	1000	€4.29
LT 514	RK 5214	€7.25	1000	€5.58
LT 609	RK 6109, RK 61509, RK 6209	€6.71	1000	€5.16
LT 614	RK 6214	€8.74	1000	€6.72

- For dividing lengthwise
- Better overview
- Made of blue-coated special plastic

4 | SAFETY HANDLE RK

Article No.	Suitable for	Price for single unit	Units on pallet	Unit price on pallet
SB 117	RK 3109, RK 4109, RK 5109, RK 6109	€1.68	500	€1.29
SB 156	RK 31509, RK 41509, RK 51509, RK 61509	€1.69	500	€1.30
SB 234	RK 3209, RK 4209, RK 5209, RK 6209, RK 3214, RK 4214, RK 5214, RK 6214	€1.72	500	€1.32

- Holds box when tilted
- Acts as a carrying handle
- Galvanised steel
- Handle lowers automatically during stacking and insertion into rack

5 | DUST LID RK

transparent

Article No.	Suitable for	Price for single unit	Units on pallet	Unit price on pallet
SD 3117	RK 3109	€2.07	500	€1.59
SD 3156	RK 31509	€2.41	500	€1.85
SD 3234	RK 3209, RK 3214	€2.99	500	€2.30
SD 4117	RK 4109	€2.41	500	€1.85
SD 4156	RK 41509	€2.76	500	€2.12
SD 4234	RK 4209, RK 4214	€3.67	500	€2.83
SD 5117	RK 5109	€2.64	500	€2.03
SD 5156	RK 51509	€3.22	500	€2.47
SD 5234	RK 5209, RK 5214	€4.25	500	€3.27
SD 6117	RK 6109	€2.99	500	€2.30
SD 6156	RK 61509	€3.67	500	€2.83
SD 6234	RK 6209, RK 6214	€4.94	500	€3.80

- Provides protection from damage and dirt
- With grab hole for easier removal
- Made of clear Plexiglas

6 | PERFORATED LABELS RK

RAL 9016

Article No.	Suitable for	Number of labels per pack	1 - 9 per unit	starting at 10 per unit
QT PE 109	QT 109	300	€27.39	€21.07
ES PE 109	ES 109	300	€27.37	€21.06
QT PE 1509	QT 1509	300	€27.39	€21.07
ES PE 1509	ES 1509	300	€27.37	€21.06
QT PE 209	QT 209	150	€27.39	€21.07
ES PE 209	ES 209	150	€27.37	€21.06
QT PE 214	QT 214	75	€27.39	€21.07
ES PE 214	ES 214	75	€27.37	€21.06

- Perforated labels
- 140 g/sqm
- Suitable for inkjet and laser printing

PARTITIONS RK

AVAILABLE UP FROM 1 PIECE
no minimum purchase order.

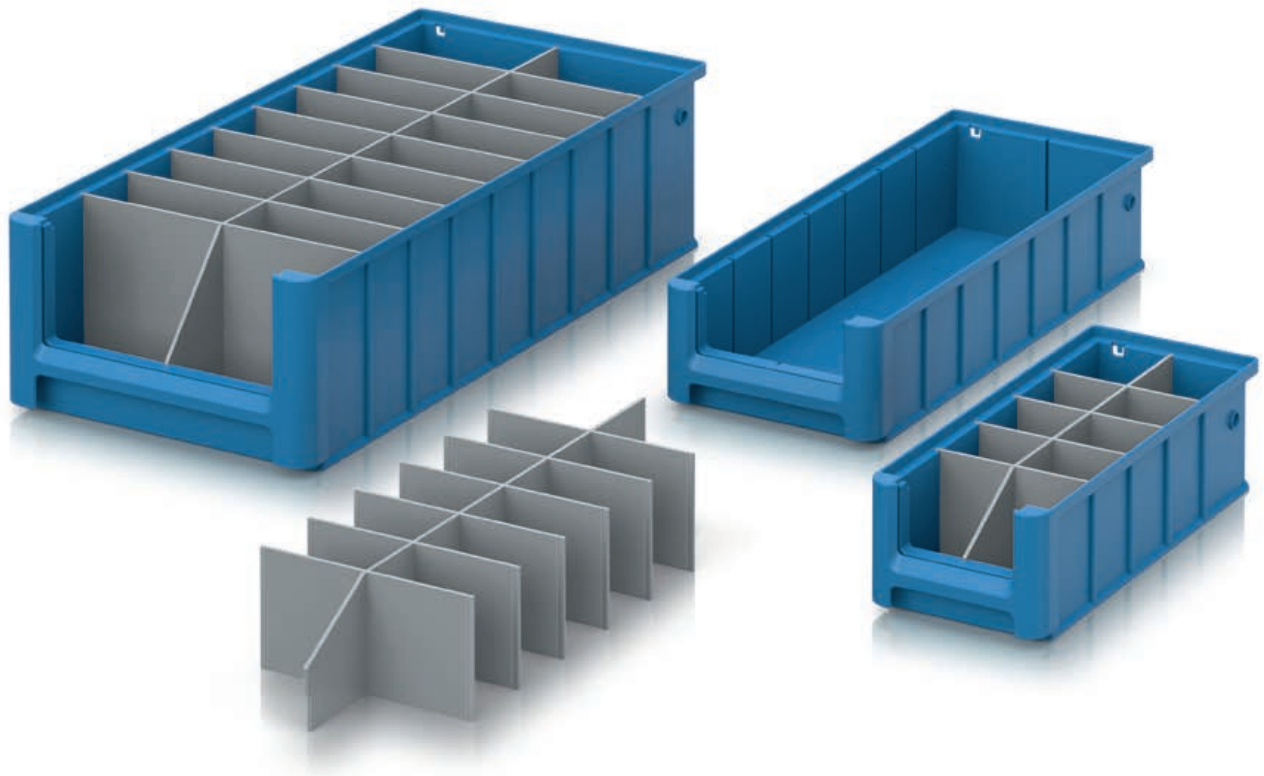

More finely subdivided

To bring even more order to your small parts, you can additionally divide the rack boxes into several smaller segments using precisely fitting partitions. The partitions are inserted into the guide slots on the walls of the containers to ensure a secure hold.

- Clean subdivision of rack boxes
- Fixed in guide slots to prevent slipping
- Front edge ergonomically bevelled
- Different dividers available for each rack box

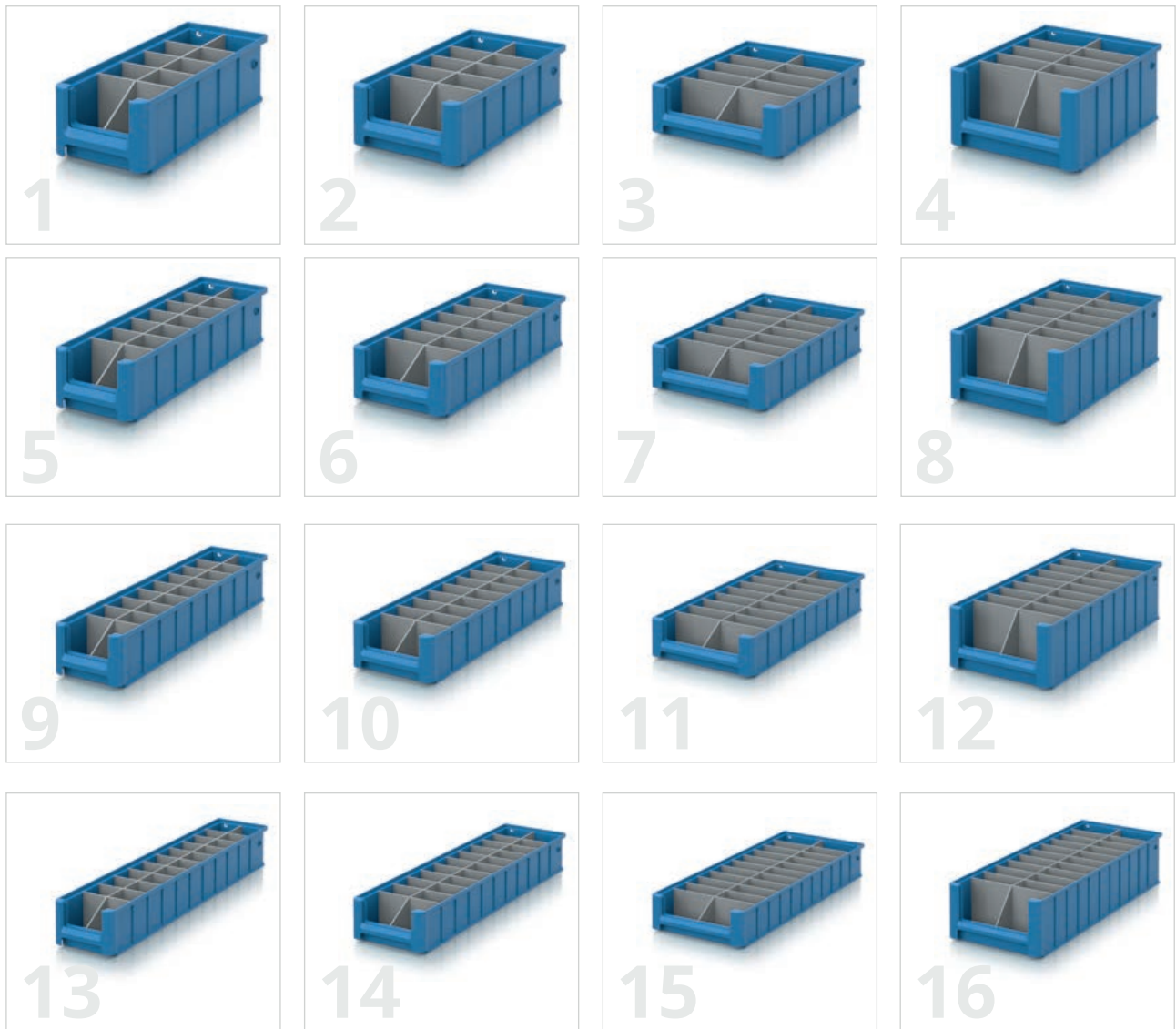

PARTITIONS RK

RAL 7001

Article No.	Suitable for	Longitudinal dividers	Travers dividers	Unit price	
1	RK GEF 3109	RK 3109	1	4	€17.37
2	RK GEF 31509	RK 31509	1	4	€17.68
3	RK GEF 3209	RK 3209	1	4	€18.51
4	RK GEF 3214	RK 3214	1	4	€19.86
5	RK GEF 4109	RK 4109	1	6	€23.35
6	RK GEF 41509	RK 41509	1	6	€23.82
7	RK GEF 4209	RK 4209	1	6	€25.06
8	RK GEF 4214	RK 4214	1	6	€27.66
9	RK GEF 5109	RK 5109	1	8	€29.33
10	RK GEF 51509	RK 51509	1	8	€29.95
11	RK GEF 5209	RK 5209	1	8	€31.62
12	RK GEF 5214	RK 5214	1	8	€35.05
13	RK GEF 6109	RK 6109	1	10	€35.28
14	RK GEF 61509	RK 61509	1	10	€36.06
15	RK GEF 6209	RK 6209	1	10	€40.43
16	RK GEF 6214	RK 6214	1	10	€46.51



STORAGE BOXES WITH OPEN FRONT EURO FORMAT



AVAILABLE UP FROM 1 PIECE
no minimum purchase order.

SPECIAL COLOURS
Simply order online

READY FOR DISPATCH **24** hours**
within

Be up-to-date with small components

AUER Packaging's storage box with open front in Euro sizes is easy to load and unload, whether as a stand-alone unit or when stacked. This container helps you to be up-to-date with your products, tools and small components. The optional acrylic glass panel prevents your contents from falling out, getting covered in dust or being damaged.

- For tools and small parts
- Comfortable loading and unloading
- Acrylic glass panel optional
- Cut-out also possible on the long side

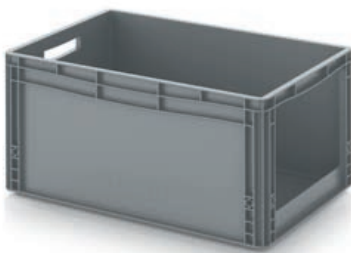

STORAGE BOXES WITH OPEN FRONT EURO FORMAT SLK FRONT OPEN

RAL 7001

Outer dimensions L x W x H (cm)	Article No.	Viewing/access opening W x H (cm)	Price for single unit	Units on pallet	Unit price on pallet
30 x 20 x 17	SLK 32/17 HG	11.4 x 10.8	€7.90	260	€6.08
40 x 30 x 17	SK S 43/17	21.0 x 9.6	€10.01	130	€7.70
40 x 30 x 22	SLK 43/22	20.0 x 12.0	€8.01	140	€6.16
40 x 30 x 27	SLK 43/27	20.0 x 17.0	€7.84	80	€6.03
40 x 30 x 32	SLK 43/32	20.0 x 22.0	€9.11	70	€7.01
60 x 40 x 17	SK S 64/17	31.0 x 9.6	€13.00	65	€10.00
60 x 40 x 22	SLK 64/22	31.0 x 13.0	€11.49	50	€8.84
60 x 40 x 27	SLK 64/27	31.0 x 18.0	€13.16	40	€10.12
60 x 40 x 32	SLK 64/32	31.0 x 22.0	€13.45	45	€10.35
60 x 40 x 42	SLK 64/42	31.0 x 22.0	€16.70	25	€12.85
80 x 60 x 32	SK S 86/32	49.0 x 21.0	€32.21	12	€24.78
80 x 60 x 42	SK S 86/42	48.8 x 30.6	€39.12	10	€30.09
80 x 60 x 52	SK S 86/52	49.0 x 41.0	€48.20	8	€37.07



***) only for orders placed via the online shop. Dispatch only on working days, provided the goods are in stock. Information regarding availability and current dispatch times can be found in the online shop.

STORAGE BOXES WITH OPEN FRONT IN EURO FORMAT WITH ACRYLIC VIEWING FLAP FRONT OPEN

RAL 7001

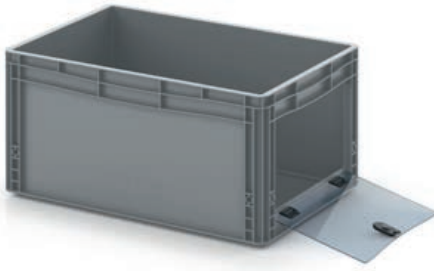

Outer dimensions L x W x H (cm)	Article No.	Viewing/access opening W x H (cm)	Price for single unit	Units per pallet	Unit price on pallet
30 x 20 x 17	EG SKS 32/17 HG	10.1 x 9.0	€20.44	260	€15.72
40 x 30 x 17	EG SKS 43/17 HG	20.0 x 9.1	€24.16	130	€18.58
40 x 30 x 22	EG SKS 43/22 HG	20.0 x 14.1	€24.02	140	€18.48
40 x 30 x 27	EG SKS 43/27 HG	20.0 x 13.4	€24.66	80	€18.97
40 x 30 x 32	EG SKS 43/32 HG	20.0 x 18.4	€25.76	70	€19.81
60 x 40 x 17	EG SKS 64/17 HG	29.8 x 9.1	€25.95	65	€19.96
60 x 40 x 22	EG SKS 64/22 HG	29.8 x 14.1	€27.27	50	€20.97
60 x 40 x 27	EG SKS 64/27 HG	29.8 x 13.3	€29.34	40	€22.57
60 x 40 x 32	EG SKS 64/32 HG	29.8 x 18.3	€30.67	45	€23.59
60 x 40 x 42	EG SKS 64/42 HG	29.8 x 28.3	€34.30	25	€26.39



STORAGE BOXES WITH OPEN FRONT EURO FORMAT SK LONG SIDE OPEN

RAL 7001



Outer dimensions L x W x H (cm)	Article No.	Viewing/access opening W x H (cm)	Price for single unit	Units on pallet	Unit price on pallet
30 x 20 x 17	SK L 32/17 HG	21.2 x 9.6	€8.35	260	€6.42
40 x 30 x 17	SK L 43/17	31.0 x 9.6	€10.68	130	€8.21
40 x 30 x 22	SK L 43/22	31.0 x 14.6	€11.94	140	€9.18
40 x 30 x 27	SK L 43/27	31.0 x 19.7	€12.57	80	€9.67
40 x 30 x 32	SK L 43/32	31.0 x 24.6	€13.67	70	€10.52
60 x 40 x 17	SK L 64/17	51.0 x 9.6	€13.86	65	€10.66
60 x 40 x 22	SK L 64/22	51.0 x 14.5	€15.18	50	€11.68
60 x 40 x 27	SK L 64/27	51.0 x 19.5	€17.25	40	€13.27
60 x 40 x 32	SK L 64/32	51.0 x 24.5	€18.58	45	€14.29
60 x 40 x 42	SK L 64/42	51.0 x 31.3	€22.22	25	€17.09
80 x 60 x 32	SK L 86/32	69.0 x 20.6	€34.36	12	€26.43
80 x 60 x 42	SK L 86/42	69.0 x 30.6	€41.73	10	€32.10
80 x 60 x 52	SK L 86/52	69.0 x 40.6	€51.41	8	€39.55



STORAGE BOXES WITH OPEN FRONT IN EURO FORMAT WITH ACRYLIC VIEWING FLAP LONG SIDE OPEN

RAL 7001



Outer dimensions L x W x H (cm)	Article No.	Viewing/access opening W x H (cm)	Price for single unit	Units per pallet	Unit price on pallet
30 x 20 x 17	EG SKL 32/17 HG	20.2 x 9.0	€20.44	260	€15.72
40 x 30 x 17	EG SKL 43/17 HG	29.8 x 9.1	€22.76	130	€17.51
40 x 30 x 22	EG SKL 43/22 HG	29.8 x 14.1	€24.02	140	€18.48
40 x 30 x 27	EG SKL 43/27 HG	29.8 x 13.4	€24.66	80	€18.97
40 x 30 x 32	EG SKL 43/32 HG	29.8 x 18.4	€25.76	70	€19.81
60 x 40 x 17	EG SKL 64/17 HG	49.8 x 9.1	€25.95	65	€19.96
60 x 40 x 22	EG SKL 64/22 HG	49.8 x 14.1	€27.27	50	€20.97
60 x 40 x 27	EG SKL 64/27 HG	49.8 x 13.3	€29.34	40	€22.57
60 x 40 x 32	EG SKL 64/32 HG	49.8 x 18.3	€30.67	45	€23.59
60 x 40 x 42	EG SKL 64/42 HG	49.8 x 28.3	€34.30	25	€26.39



DRAWER CONTAINERS COMPLETE SYSTEM

AVAILABLE UP FROM 1 PIECE
no minimum purchase order.

READY FOR DISPATCH within **24** hours **

2 | SB-S2+.2

1 | SB-S1.2



Always at hand

AUER Packaging's drawer container is both practical and inexpensive. Thanks to its rugged modular design, the system can accommodate a large number of parts. The complete system consists of a transport trolley and drawer container, two drawer holders and six drawers. Also available as single components.

- Total load-bearing capacity: 70 kg
- 12 insertion grooves for drawers
- 2-12 drawers per container
- Stops prevent the drawers from sliding out

DRAWER CONTAINERS COMPLETE SYSTEM

RAL 7001

Article No.	Equipment	Price for single unit	Units on pallet	Unit price on pallet
1 SB-S1.2	1 x Container equipped with: 1 x SB.H, 1 x W24-t, 1 x W84-t, 1 x W172-t	€130.44	25	€100.34
2 SB-S2+.2	2 x Container equipped with: 2 x SB.H, 2 x W24-t, 2 x W84-t, 2 x W172-t, 1 x RO 64 GU FE	€284.89	15	€219.15

» Find ESD version on page 206



***) only for orders placed via the online shop. Dispatch only on working days, provided the goods are in stock. Information regarding availability and current dispatch times can be found in the online shop.

DRAWER CONTAINERS SINGLE COMPONENTS



DRAWER CONTAINERS

RAL 7001

	Outer dimensions L x W x H (cm)	Article No.	Description	Price for single unit	Units on pallet	Unit price on pallet
3	60.0 x 40.0 x 43.5	SB.42.2	Drawer container including a hinged lid with an open long side	€22.61	25	€17.39

DRAWER HOLDER

RAL 9017

	Outer dimensions L x W x H (cm)	Article No.	Description	Price for single unit	Units on pallet	Unit price on pallet
4	40.8 x 36.7 x 3.4	SB.H	Drawer holder with a maximum of 12 insertion grooves	€11.72	100	€9.01

TRANSPORT TROLLEYS

RAL 3020

	Outer dimensions L x W x H (cm)	Article No.	Description	Price for single unit	Units on pallet	Unit price on pallet
5	62 x 42	RO 64.4 GU FE-3020	2 steering castors, 2 steering castors with wheel stop	€40.55	80	€31.19

DRAWERS

transparent

	Outer dimensions L x W x H (cm)	Article No.	Description	Price for single unit	Units on pallet	Unit price on pallet
6	52.0 x 35.7 x 2.4	W24-t	Drawer, up to 12 drawers per box	€21.45	510	€16.50
7	52.0 x 35.7 x 8.4	W84-t	Drawer, up to 4 drawers per box	€33.74	288	€25.96
8	52.0 x 35.7 x 17.2	W172-t	Drawer, up to 2 drawers per box	€41.37	135	€31.82

TIPPING BOX SETS

AVAILABLE UP FROM 1 PIECE
no minimum purchase order.

READY FOR DISPATCH
within **24** hours **



Keeping tabs on everything

AUER Packaging's tipping box helps you to keep tabs on things at all times since the contents are instantly recognisable in the transparent box. Complete flexibility when loading or removing the contents: the boxes are really easy to tip forward or to remove completely.

- Transparent plastic
- Especially scratch-resistant
- Individually stackable

***) only for orders placed via the online shop. Dispatch only on working days, provided the goods are in stock. Information regarding availability and current dispatch times can be found in the online shop.

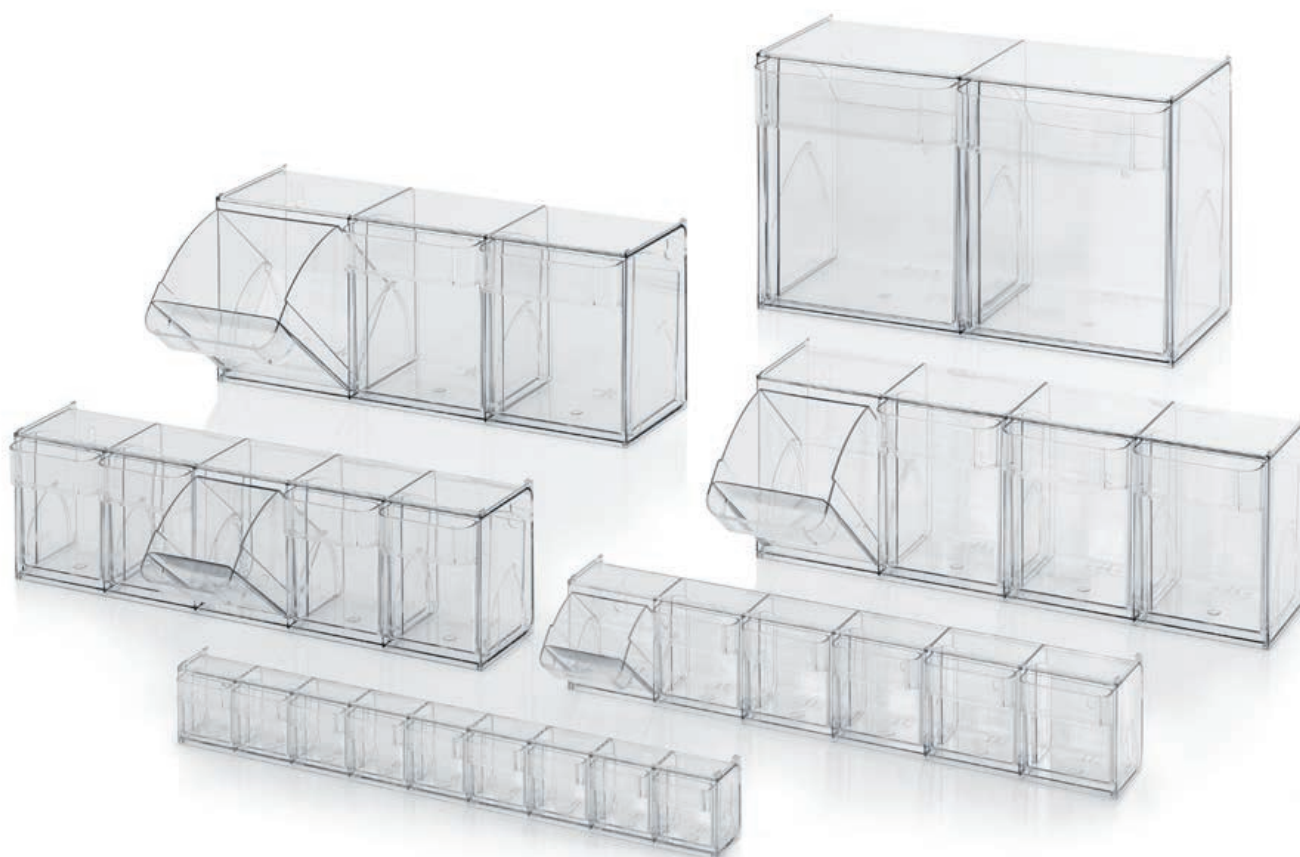

TIPPING BOX SETS

transparent

Outer dimensions W x D x H (cm)	Article No.	Made up of	Price for single unit	Units on pallet	Unit price on pallet
60 x 6.2 x 7.7	KKS 9 t	1 Tipping box module, 9 containers	€13.52	644	€10.40
60 x 9.1 x 11.3	KKS 6 t	1 Tipping box module, 6 containers	€16.81	340	€12.93
60 x 13.3 x 16.4	KKS 5 t	1 Tipping box module, 5 containers	€27.02	154	€20.78
60 x 16.8 x 20.7	KKS 4 t	1 Tipping box module, 4 containers	€33.41	90	€25.70
60 x 19.7 x 24.0	KKS 3 t	1 Tipping box module, 3 containers	€37.37	80	€28.75
60 x 29.9 x 35.3	KKS 2 t	1 Tipping box module, 2 containers	€68.34	35	€52.57



PERFORATED LABELS FOR TIPPING BOXES

RAL 9016

Suitable for	Article No.	Number of labels per pack	1 - 9 per unit	starting at 10 per unit
EBKK 9	PE 9	1200	€27.39	€21.07
EBKK 6	PE 6	500	€27.39	€21.07
EBKK 5	PE 5	350	€27.39	€21.07
EBKK 4	PE 4	300	€27.39	€21.07
EBKK 3	PE 3	150	€27.39	€21.07
EBKK 2	PE 2	50	€27.39	€21.07



PAILS & SCREW-TOP JARS

Goods under lock and key



PAILS ROUND



AVAILABLE UP FROM 1 PIECE
no minimum purchase order.

SPECIAL COLOURS
Simply order online

READY FOR DISPATCH within **24 hours** **

The classic pail

AUER Packaging's round pail is the tried and trusted means of storing and transporting liquid and solid substances. It is made of food-safe plastic and can be hermetically sealed using the lid. This makes it ideal for food storage.

- ISO capacities
- Food-safe
- Customisable thanks to versatile printing options

PAILS ROUND

RAL 9016

ISO-Volume	Handle	Article No.	Diameter x Height (cm)	Price for single unit	Units on pallet	Unit price on pallet
0.55 liter	Plastic handle	ER 0,55-118+DK	11.8 x 7.5	€0.40	5440	€0.31
0.88 liter	Plastic handle	ER 0,88-118+DK	11.8 x 11.9	€0.44	4480	€0.34
0.95 liter	Plastic handle	ER 0,95-132+DK	13.2 x 10.0	€0.46	4200	€0.35
1.18 liter	Plastic handle	ER 1,18-132+DK	13.2 x 12.4	€0.48	3920	€0.37
2.60 liter	Plastic handle	ER 2,6-200+DK	20.0 x 11.6	€0.87	1540	€0.67
3.20 liter	Plastic handle	ER 3,2-200+DK	20.0 x 14.1	€0.92	1400	€0.71
3.80 liter	Plastic handle	ER 3,8-200+DK	20.0 x 16.8	€1.04	1260	€0.80
4.40 liter	Plastic handle	ER 4,4-226+DK	22.6 x 15.0	€1.15	900	€0.88
5.60 liter	Plastic handle	ER 5,6-226+DK	22.6 x 19.0	€1.35	700	€1.03
7.40 liter	Plastic handle	ER 7,4-267+DK	26.7 x 18.0	€1.56	840	€1.20
8.60 liter	Plastic handle	ER 8,6-267+DK	26.7 x 20.9	€1.78	770	€1.37
10.80 liter	Plastic handle	ER 10,8-267+DK	26.7 x 26.3	€2.09	728	€1.61
12.80 liter	Plastic handle	ER 12,8-293+DK	29.3 x 26.0	€2.55	624	€1.96
15.90 liter	Plastic handle	ER 15,9-293+DK	29.3 x 32.6	€3.02	528	€2.33
18.00 liter	Plastic handle	ER 18-326+DK	32.6 x 29.1	€3.20	414	€2.46
20.00 liter	Plastic handle	ER 20-326+DK	32.6 x 32.4	€3.56	387	€2.73
22.00 liter	without handle	ER 22-375+D	37.5 x 27.0	€3.87	336	€2.98
27.00 liter	without handle	ER 27-375+D	37.5 x 33.1	€4.51	304	€3.47
30.00 liter	without handle	ER 30-375+D	37.5 x 37.0	€5.11	288	€3.93
32.00 liter	without handle	ER 32-375+D	37.5 x 39.6	€5.58	280	€4.29

» Pails without lids as well as further handle versions are available in our ONLINE SHOP



***) only for orders placed via the online shop. Dispatch only on working days, provided the goods are in stock. Information regarding availability and current dispatch times can be found in the online shop.

PAILS OVAL



READY FOR DISPATCH
within **24 hours**

AVAILABLE UP FROM 1 PIECE
no minimum purchase order.

SPECIAL COLOURS
Simply order online

Brings colour into the game

AUER Packaging's oval pail is available in a standard white colour or in a range of special colours. It is made of food-safe plastic and can be hermetically sealed using the lid. This makes it ideal for food storage.

- 18.8 litre volume
- Food-safe
- Customisable thanks to versatile printing options

PAILS OVAL

RAL 9016

ISO-Volume	Handle	Article No.	Outer dimensions L x W x H (cm)	Price for single unit	Units on pallet	Unit price on pallet
18.8 liter	Plastic handle	EO 18,8+DK	39.1 x 30.1 x 28	€4.07	324	€3.13



***) only for orders placed via the online shop. Dispatch only on working days, provided the goods are in stock.
Information regarding availability and current dispatch times can be found in the online shop.

PAILS OBLONG

AVAILABLE UP FROM 1 PIECE
no minimum purchase order.

SPECIAL COLOURS
Simply order online



READY FOR DISPATCH **24** hours**
within

A trendsetter from every angle

With a capacity ranging from 2.6 litres to 22 litres, AUER Packaging's oblong pail is both modern and practical. It is made of food-safe plastic and can be hermetically sealed using the lid. This makes it ideal for food storage.

- ISO capacities
- Food-safe
- Customisable thanks to versatile printing options

PAILS OBLONG

RAL 9016

ISO-Volume	Handle	Article No.	Outer dimensions L x W x H (cm)	Price for single unit	Units on pallet	Unit price on pallet
2.6 liter	Plastic handle	EE 2,6-235.150+DK	23.5 x 15.0 x 11.4	€1.01	1400	€0.77
3.2 liter	Plastic handle	EE 3,2-250.169+DK	25.0 x 16.9 x 11.4	€1.12	1200	€0.86
4.4 liter	Plastic handle	EE 4,4-286.198+DK	28.5 x 19.7 x 11.9	€1.46	900	€1.12
5.6 liter	Plastic handle	EE 5,6-286.198+DK	28.5 x 19.7 x 14.8	€1.69	800	€1.30
10.3 liter	Plastic handle	EE 10,3-286.198+DK	28.6 x 19.8 x 27.3	€2.40	816	€1.85
12.8 liter	Plastic handle	EE 12,8-372.240+DK	37.1 x 23.9 x 20.8	€3.14	528	€2.42
16.6 liter	Plastic handle	EE 16,6-372.240+DK	37.2 x 24.0 x 27.0	€3.74	480	€2.88
17.0 liter	Plastic handle	EE 17-395.295+DK	39.4 x 29.4 x 21.1	€4.20	360	€3.23
20.0 liter	Plastic handle	EE 20-395.295+DK	39.4 x 29.4 x 24.7	€4.74	324	€3.65
22.0 liter	Plastic handle	EE 22-395.295+DK	39.5 x 29.5 x 27.2	€5.24	306	€4.03



***) only for orders placed via the online shop. Dispatch only on working days, provided the goods are in stock.
Information regarding availability and current dispatch times can be found in the online shop.



Special effects

In-mould labelling (IML) is a printing method, which lets your buckets shine in individual and brilliant design. The design options are limitless: Photos and graphics are printed in impressive high-resolution quality and can be supplemented with stunning effects. You have the choice of a wide variety of finishing options - from scented prints diffusing a selective aroma upon touching, across velvety soft surfaces to Thermocrom colours that change depending on the temperature. You are welcome to instruct our staff regarding your request printing!

- Scented prints
- Tactile effects
- Black light effects
- Thermocrom colours
- Partial UV finishes
- Metallic effects
- Removable prints
- Digital watermarks

SCREW-TOP JARS

AVAILABLE UP FROM 1 PIECE
no minimum purchase order.



READY FOR DISPATCH
within **24 hours**

Protected in next to no time

The screw-top jar by AUER Packaging features impressive tactile details which make handling especially comfortable and ergonomic. The comfort handle makes it easy to open and close the jar and is also used as a carrying handle. A separate inner lid or a seal integrated in the 2-piece lid ensures that the contents of the screw-top jar are reliably protected against external influences.

- Food-safe
- Water vapour-tight
- Stackable

STANDARD COLOURS

F1 Lid RAL 110 80 70 Lime green	F2 Lid RAL 1003 signal yellow	F3 Lid RAL 3020 traffic red	F4 Lid RAL 5005 signal blue	F5 Lid RAL 7016 anthracite grey	F6 Lid RAL 9016 traffic white
---	---	---------------------------------------	---------------------------------------	---	---

***) only for orders placed via the online shop. Dispatch only on working days, provided the goods are in stock.
Information regarding availability and current dispatch times can be found in the online shop.



SCREW-TOP JARS BASIC WITHOUT INNER LID

ISO-Volume	Article No.	Diameter x Height (cm)	Price for single unit	Units on pallet	Unit price on pallet
0.30 liter	SC A 0.3-99 F3	11.1 x 5.5	€1.69	2250	€1.30
0.50 liter	SC A 0.5-99 F3	11.1 x 8.2	€1.83	1350	€1.41
0.65 liter	SC A 0.65-99 F3	11.1 x 10.3	€1.87	1350	€1.44
1.00 liter	SC A 1.0-99 F3	11.1 x 15.2	€2.05	720	€1.58
1.30 liter	SC A 1.3-99 F3	11.1 x 19.4	€2.25	450	€1.73
1.50 liter	SC A 1.5-119 F3	13.2 x 16.0	€2.54	640	€1.96
2.00 liter	SC A 2.0-119 F3	13.2 x 20.9	€2.82	320	€2.17
2.50 liter	SC A 2.5-119 F3	13.2 x 25.8	€3.01	320	€2.31



SCREW-TOP JARS BASIC WITH INNER LID

ISO-Volume	Article No.	Diameter x Height (cm)	Price for single unit	Units on pallet	Unit price on pallet
0.30 liter	SC I 0.3-99 F3	11.1 x 5.5	€1.90	2250	€1.46
0.50 liter	SC I 0.5-99 F3	11.1 x 8.2	€2.05	1350	€1.57
0.65 liter	SC I 0.65-99 F3	11.1 x 10.3	€2.08	1350	€1.60
1.00 liter	SC I 1.0-99 F3	11.1 x 15.2	€2.27	720	€1.74
1.30 liter	SC I 1.3-99 F3	11.1 x 19.4	€2.47	450	€1.90
1.50 liter	SC I 1.5-119 F3	13.2 x 16.0	€2.80	640	€2.15
2.00 liter	SC I 2.0-119 F3	13.2 x 20.9	€3.07	320	€2.36
2.50 liter	SC I 2.5-119 F3	13.2 x 25.8	€3.26	320	€2.51

» Select your preferred colour by changing the colour abbreviation (F3) in the item number.



SCREW-TOP JARS WITH COMFORT HANDLE WITHOUT INNER LID

ISO-Volume	Article No.	Diameter x Height (cm)	Price for single unit	Units on pallet	Unit price on pallet
0.30 liter	SC AG 0.3-99 F3	11.1 x 7.7	€2.31	1800	€1.77
0.50 liter	SC AG 0.5-99 F3	11.1 x 10.5	€2.36	1350	€1.82
0.65 liter	SC AG 0.65-99 F3	11.1 x 12.6	€2.40	900	€1.85
1.00 liter	SC AG 1.0-99 F3	11.1 x 17.4	€2.52	900	€1.94
1.30 liter	SC AG 1.3-99 F3	11.1 x 21.7	€2.71	450	€2.08
1.50 liter	SC AG 1.5-119 F3	13.1 x 18.3	€3.30	320	€2.54
2.00 liter	SC AG 2.0-119 F3	13.1 x 23.2	€3.41	320	€2.62
2.50 liter	SC AG 2.5-119 F3	13.1 x 28.1	€3.60	320	€2.77



SCREW-TOP JARS WITH COMFORT HANDLE WITH INNER LID

ISO-Volume	Article No.	Diameter x Height (cm)	Price for single unit	Units on pallet	Unit price on pallet
0.30 liter	SC IG 0.3-99 F3	11.1 x 7.7	€2.54	1800	€1.95
0.50 liter	SC IG 0.5-99 F3	11.1 x 10.5	€2.57	1350	€1.98
0.65 liter	SC IG 0.65-99 F3	11.1 x 12.6	€2.62	900	€2.01
1.00 liter	SC IG 1.0-99 F3	11.1 x 17.4	€2.73	900	€2.10
1.30 liter	SC IG 1.3-99 F3	11.1 x 21.7	€2.92	450	€2.25
1.50 liter	SC IG 1.5-119 F3	13.1 x 18.3	€3.55	320	€2.73
2.00 liter	SC IG 2.0-119 F3	13.1 x 23.2	€3.67	320	€2.82
2.50 liter	SC IG 2.5-119 F3	13.1 x 28.1	€3.86	320	€2.97

» Select your preferred colour by changing the colour abbreviation (F3) in the item number.



PLASTIC PALLETS

The smart alternative



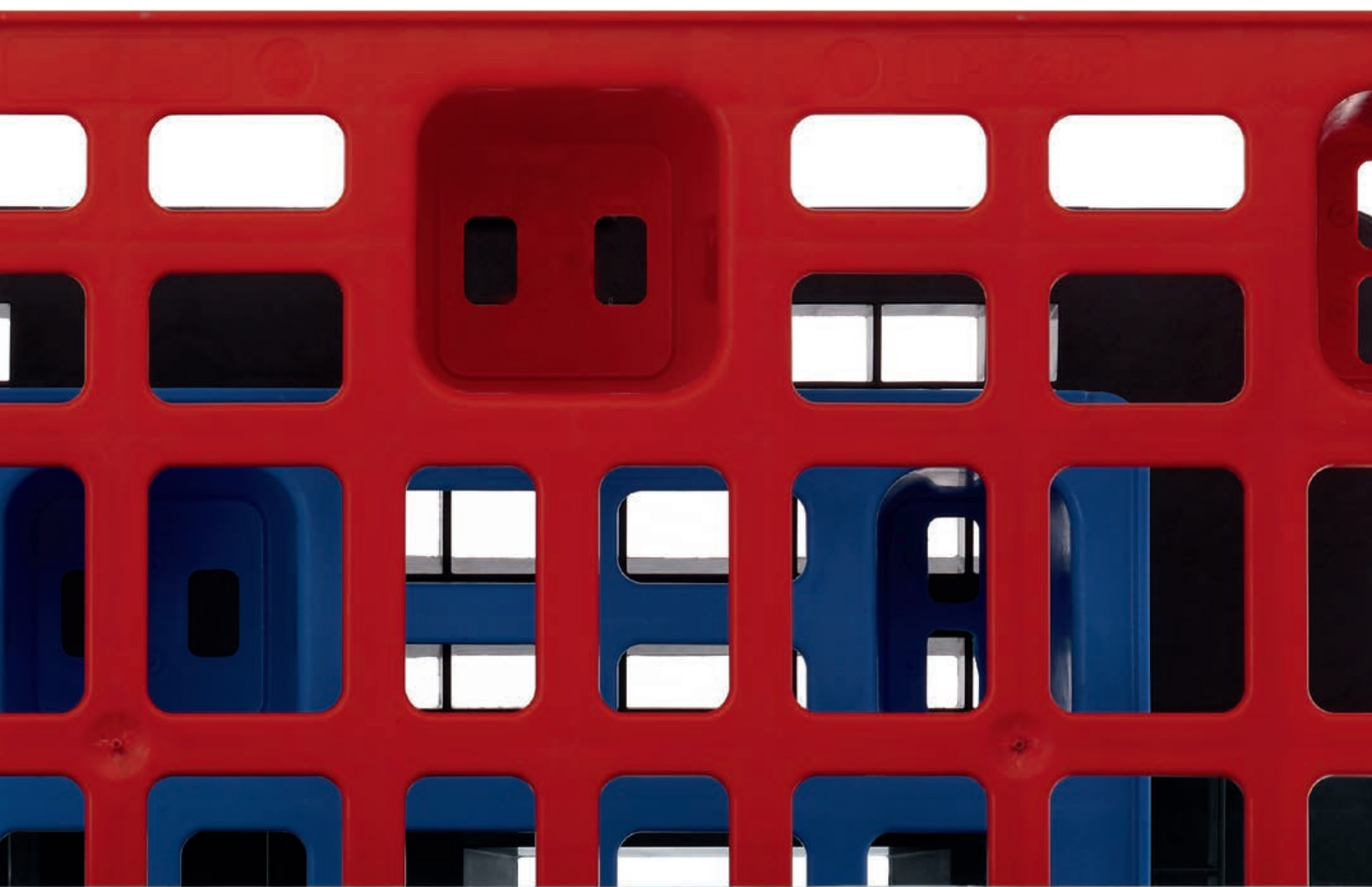

LIGHTWEIGHT PALLETS WITH RETAINING EDGE WITH FEET

AVAILABLE UP FROM 1 PIECE
no minimum purchase order.

SPECIAL COLOURS
Simply order online

READY FOR DISPATCH
within **24** hours **

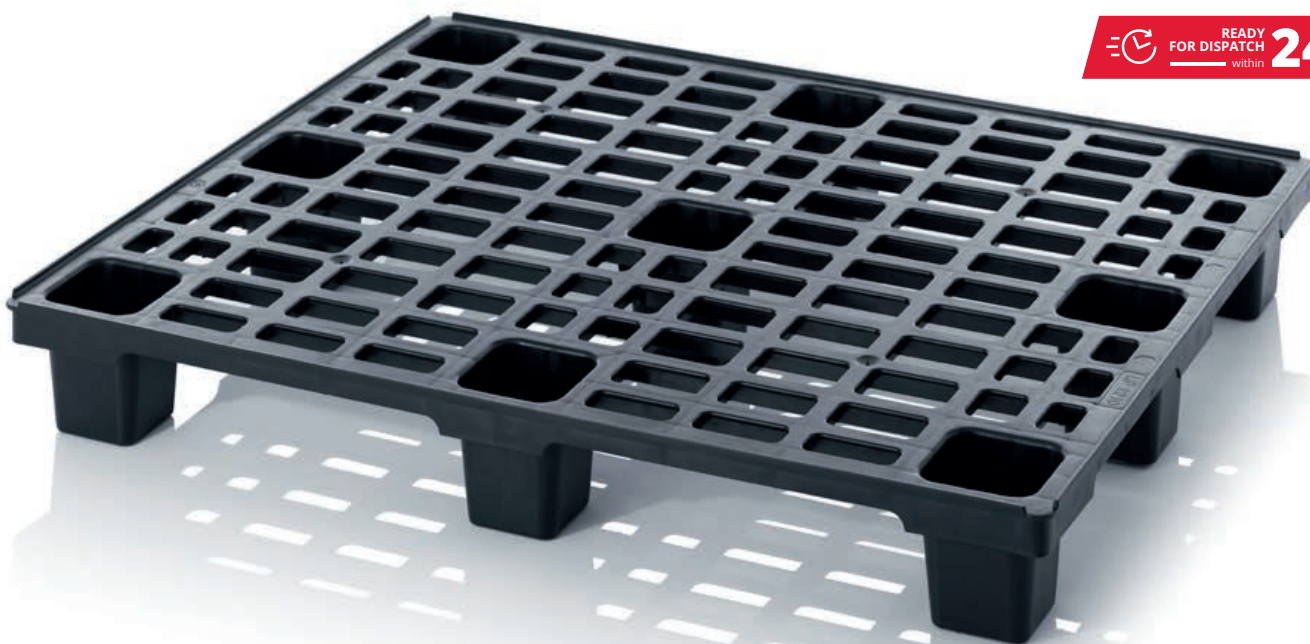

Sturdy lightweights

The outstanding property of AUER Packaging's lightweight pallet is its especially low empty weight. It nevertheless has an impressive load-bearing capacity and is therefore suitable for use in worldwide transportation. Light pallets with legs can be stored inside each other to save space and skids provide optimal stability especially for large loads.

- Can be stacked inside each other to save space
- Low empty weight
- Very resilient
- Suitable for worldwide exports

LIGHTWEIGHT PALLETS WITH RETAINING EDGE WITH FEET

RAL 9017

Outer dimensions L x W (cm)	Article No.	Design	Price for single unit	Units per stack on truck	Unit price on truck
60 x 40	LP 64	with 4 feet	€5.79	200	€4.46
80 x 60	LP 86	with 6 feet	€9.26	100	€7.13
120 x 80	LP 1208	with 9 feet	€16.20	50	€12.46
120 x 100	LP 1210	with 9 feet	€20.83	50	€16.02

- » The design **without the safety edge** can be found in our online shop
- » Find ESD version on page 224



***) only for orders placed via the online shop. Dispatch only on working days, provided the goods are in stock.
Information regarding availability and current dispatch times can be found in the online shop.

LIGHTWEIGHT PALLETS WITH RETAINING EDGE WITH SKIDS

AVAILABLE UP FROM 1 PIECE
no minimum purchase order.

SPECIAL COLOURS
Simply order online

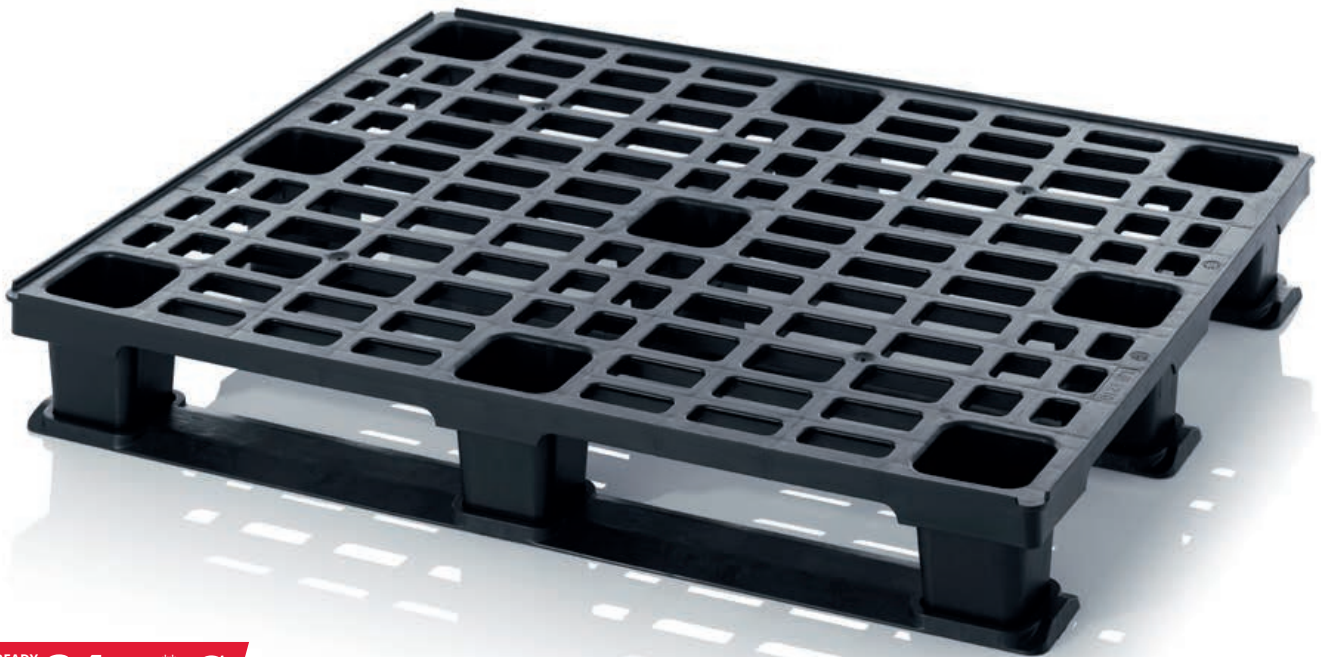

READY FOR DISPATCH within **24 hours**

The stable ones

Due to the skids, our lightweight pallets become even more stable as well as the torsional stiffness increases. Especially high weights, this pallets can be perfectly moved with fork lifters.

- Optimum stability
- Low net weight
- High load-bearing capacity
- Suitable for global export

LIGHTWEIGHT PALLETS WITH RETAINING EDGE WITH SKIDS

RAL 9017

Outer dimensions L x W (cm)	Article No.	Design	Price for single unit	Units per stack on truck	Unit price on truck
120 x 80	LP 1208K	with 3 skids	€22.33	15	€17.18
120 x 100	LP 1210K	with 3 skids	€27.56	15	€21.20

- » The design **without the safety edge** can be found in our online shop
- » Find ESD version on page 224



***) only for orders placed via the online shop. Dispatch only on working days, provided the goods are in stock. Information regarding availability and current dispatch times can be found in the online shop.

MEDIUM PALLETS WITH RETAINING EDGE

AVAILABLE UP FROM 1 PIECE
no minimum purchase order.

READY FOR DISPATCH **24** hours**
within



Strong all-rounders

AUER Packaging's medium pallet is made of scratch-resistant, high-quality plastic and is an all-rounder in day-to-day service with load-bearing capacities between those of the lightweight and the hygienic pallet. It is suitable for worldwide exports and, with steel tube reinforcements, is also ideal for use in high-bay warehouses.

- Euro and ISO format
- With or without retaining edge
- Optional steel rod reinforcement
- Suitable for worldwide exports

MEDIUM PALLETS WITH RETAINING EDGE

RAL 9017

Outer dimensions L x W (cm)	Article No.	Design	Price for single unit	Units per stack on truck	Unit price on truck
120 x 80	MP 1208	with 3 skids	€54.07	14	€41.60
120 x 80	MPHD 1208	with 3 skids and steel tube reinforcements	€66.93	14	€51.49
120 x 100	MP 1210	with 3 skids	€40.99	14	€31.53
120 x 100	MPHD 1210	with 3 skids and steel tube reinforcements	€56.49	14	€43.46
120 x 100	MP 12105	with 5 skids	€43.59	14	€33.53
120 x 100	MPHD 12105	with 2 transverse and 3 longitudinal skids and steel tube reinforcements	€59.10	14	€45.46

- » The design **without the safety edge** can be found in our online shop
- » ESD version available in our online shop



***) only for orders placed via the online shop. Dispatch only on working days, provided the goods are in stock. Information regarding availability and current dispatch times can be found in the online shop.

HYGIENE PALLETS WITH RETAINING EDGE

AVAILABLE UP FROM 1 PIECE
no minimum purchase order.

SPECIAL COLOURS
Simply order online

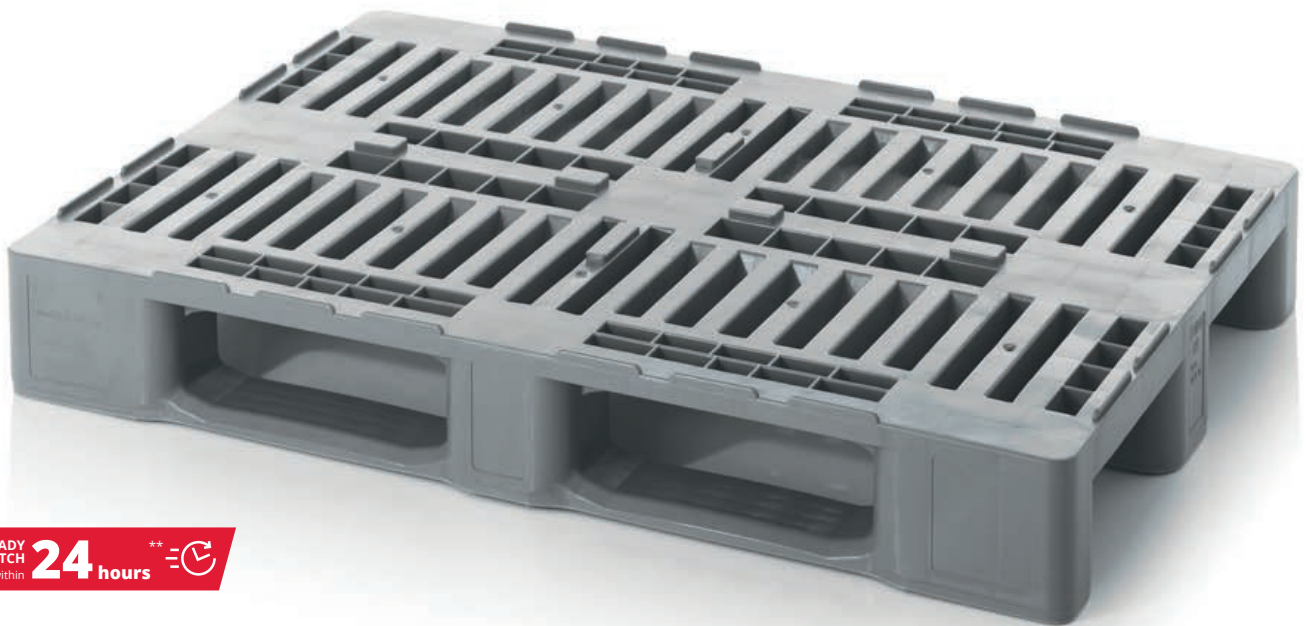

Clean maximum performance

AUER Packaging's hygienic pallet is also known as the H1 or H3 pallet. It has been specially developed for the storage and transportation of foodstuffs. Its standardised external dimensions make it the perfect basis for hygienically flawless stackable containers and also suitable for worldwide exports.

- Food-safe
- Suitable for worldwide exports
- Heat and cold-resistant
- Easy to clean

HYGIENE PALLETS WITH RETAINING EDGE

RAL 7001

Outer dimensions L x W (cm)	Article No.	Design	Price for single unit	Units per stack on truck	Unit price on truck
120 x 80	H1	3 skids welded	€92.97	14	€71.51
120 x 80	H1-RG	3 skids not welded	€81.54	14	€62.72
120 x 100	H3	3 skids not welded	€63.02	14	€48.48
120 x 100	H3+5	5 skids not welded	€67.79	14	€52.15

» The design **without the safety edge** can be found in our online shop



***) only for orders placed via the online shop. Dispatch only on working days, provided the goods are in stock. Information regarding availability and current dispatch times can be found in the online shop.

CLEANROOM PALLETS

AVAILABLE UP FROM 1 PIECE
no minimum purchase order.

SPECIAL COLOURS
Simply order online

READY FOR DISPATCH **24** hours**
within

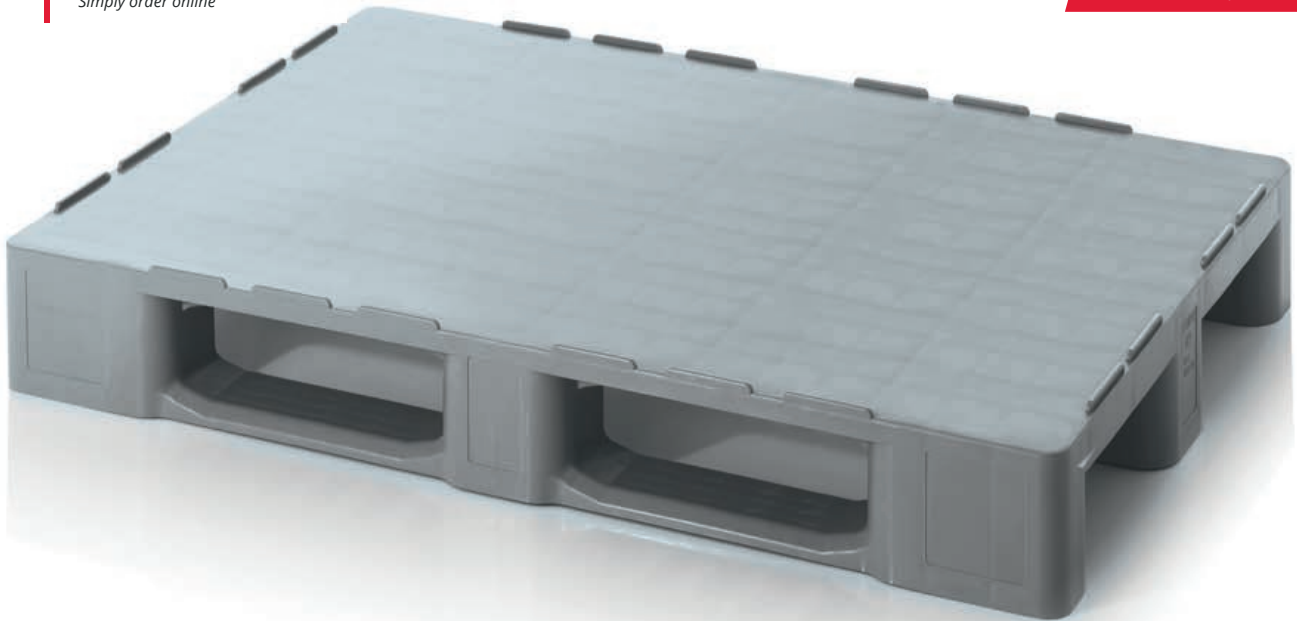

Smooth does it!

Due to its smooth, solid storage surface, AUER Packaging's cleanroom pallet is easy to clean thoroughly and consequently ideal for the storage and transportation of hygienic goods. The pallet is available either with or without a retaining edge.

- Completely smooth surface (Production-related injection points unavoidable)
- Easy-clean surface
- Suitable for high-bay racking
- Optional steel rod reinforcement

CLEANROOM PALLETS WITH RETAINING EDGE

RAL 7001

Outer dimensions L x W (cm)	Article No.	Design	Price for single unit	Units per stack on truck	Unit price on truck
120 x 80	H 1208	with 3 skids	€72.23	15	€55.56
120 x 80	HD 1208	with 3 skids and steel tube reinforcements	€87.60	15	€67.39
120 x 100	H 1210	with 3 skids	€85.62	15	€65.86
120 x 100	HD 1210	with 3 skids and steel tube reinforcements	€100.97	15	€77.67
120 x 100	H 12105	with 2 transverse and 3 longitudinal skids	€91.58	15	€70.45
120 x 100	HD 12105	with 2 transverse and 3 longitudinal skids and steel tube reinforcements	€106.92	15	€82.24



CLEANROOM PALLETS WITHOUT RETAINING EDGE

RAL 7001

Outer dimensions L x W (cm)	Article No.	Design	Price for single unit	Units per stack on truck	Unit price on truck
120 x 80	H 1208 OS	with 3 skids	€72.23	15	€55.56
120 x 80	HD 1208 OS	with 3 skids and steel tube reinforcements	€87.60	15	€67.39
120 x 100	H 1210 OS	with 3 skids	€85.62	15	€65.86
120 x 100	HD 1210 OS	with 3 skids and steel tube reinforcements	€100.97	15	€77.67
120 x 100	H 12105 OS	with 2 transverse and 3 longitudinal skids	€91.58	15	€70.45
120 x 100	HD 12105 OS	with 2 transverse and 3 longitudinal skids and steel tube reinforcements	€106.92	15	€82.24

» Find ESD version on page 225



***) only for orders placed via the online shop. Dispatch only on working days, provided the goods are in stock. Information regarding availability and current dispatch times can be found in the online shop.

CLEANROOM PALLETS MADE FROM RECLAIMED MATERIAL

AVAILABLE UP FROM 1 PIECE
no minimum purchase order.



READY FOR DISPATCH within **24 hours** **

Smooth does it!

AUER Packaging's cleanroom pallet is manufactured from reclaimed, recycled plastic material and is therefore somewhat cheaper than the version made from new material. However, this version has equally good load-bearing and cleaning properties. Please note that cleanroom pallets manufactured from reclaimed material are not food-safe.

- Made from reclaimed material
- Completely smooth surface (Production-related injection points unavoidable)
- Easy to clean
- Suitable for high-bay racking

CLEANROOM PALLETS MADE FROM RECLAIMED MATERIAL WITH RETAINING EDGE

RAL 9017

Outer dimensions L x W (cm)	Article No.	Design	Price for single unit	Units per stack on truck	Unit price on truck
120 x 80	R 1208	with 3 skids	€44.74	15	€34.41
120 x 80	RD 1208	with 3 skids and steel tube reinforcements	€60.24	15	€46.34
120 x 100	R 1210	with 3 skids	€52.29	15	€40.23
120 x 100	RD 1210	with 3 skids and steel tube reinforcements	€67.80	15	€52.15
120 x 100	R 12105	with 2 transverse and 3 longitudinal skids	€55.96	15	€43.05
120 x 100	RD 12105	with 2 transverse and 3 longitudinal skids and steel tube reinforcements	€71.47	15	€54.97



CLEANROOM PALLETS MADE FROM RECLAIMED MATERIAL WITHOUT RETAINING EDGE

RAL 9017

Outer dimensions L x W (cm)	Article No.	Design	Price for single unit	Units per stack on truck	Unit price on truck
120 x 80	R 1208 OS	with 3 skids	€44.74	15	€34.41
120 x 80	RD 1208 OS	with 3 skids and steel tube reinforcements	€60.24	15	€46.34
120 x 100	R 1210 OS	with 3 skids	€52.29	15	€40.23
120 x 100	RD 1210 OS	with 3 skids and steel tube reinforcements	€67.80	15	€52.15
120 x 100	R 12105 OS	with 2 transverse and 3 longitudinal skids	€55.96	15	€43.05
120 x 100	RD 12105 OS	with 2 transverse and 3 longitudinal skids and steel tube reinforcements	€71.47	15	€54.97



***) only for orders placed via the online shop. Dispatch only on working days, provided the goods are in stock. Information regarding availability and current dispatch times can be found in the online shop.

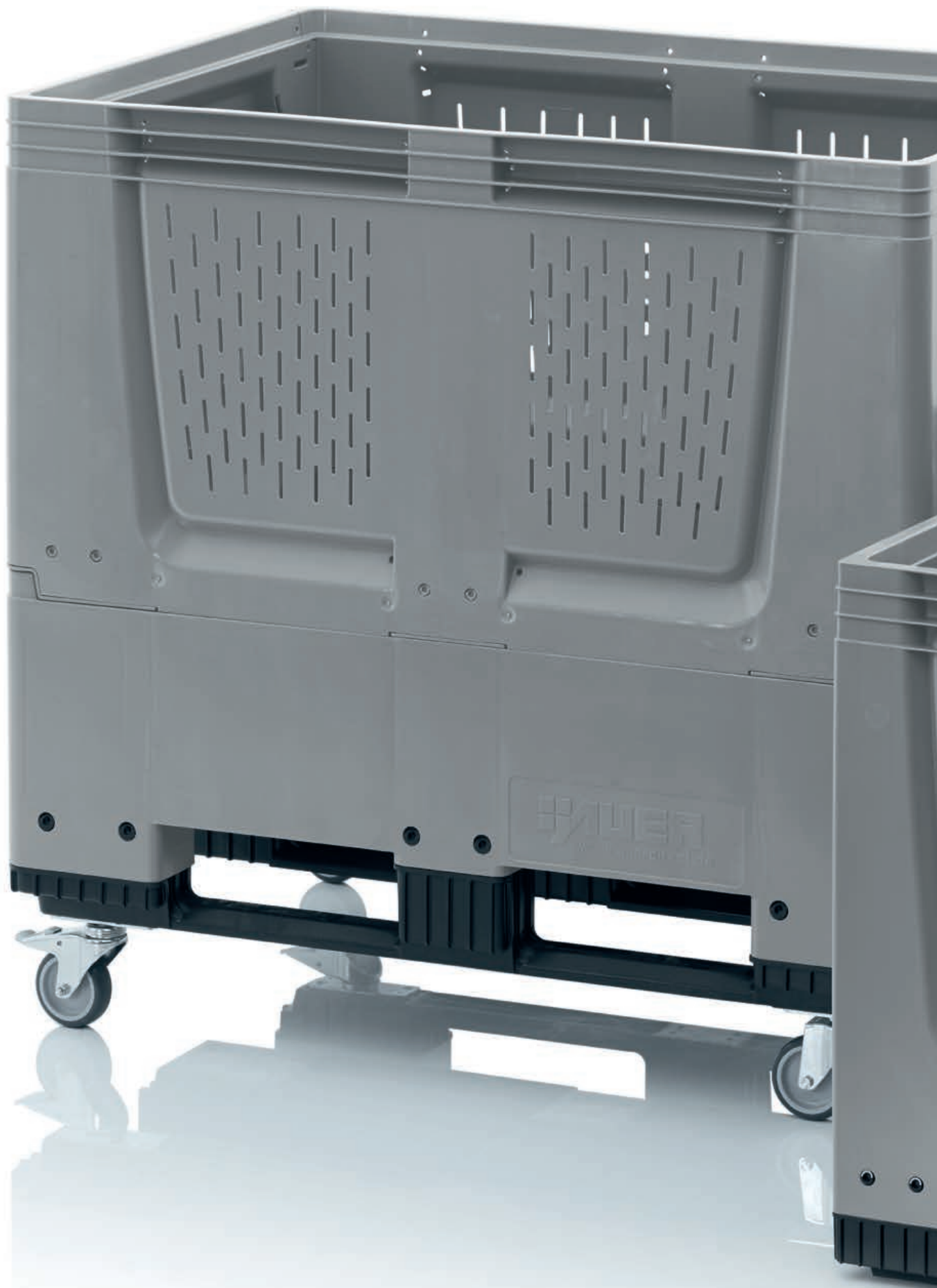



PALLET CONTAINERS

For large tasks

BIG BOXES SOLID

READY FOR DISPATCH within **24** hours **



AVAILABLE UP FROM 1 PIECE
no minimum purchase order.

SPECIAL COLOURS
Simply order online

Large, sturdy size

AUER Packaging's closed collapsible big box is characterised by its sturdy construction and solid side walls. It conforms to ISO and EURO formats and, due to its large capacity, is especially suitable for the storage and transportation of bulky, heavy goods.

- ISO and EURO formats
- Choice of skids, feet, or wheels
- Easy to clean

BIG BOXES SOLID

RAL 7001

Outer dimensions L x W x H (cm)	Article No.	Design	Price for single unit	Units per stack on truck	Unit price on truck
80 x 60 x 79	BBG 86	4 feet	€98.93	6	€76.10
80 x 60 x 93	BBG 86R	4 wheels	€123.74	6	€95.18
120 x 80 x 79	BBG 1208	4 feet	€149.65	3	€115.11
120 x 80 x 79	BBG 1208K	3 skids	€167.42	3	€128.79
120 x 80 x 79	UN BBG 1208K	3 skids, UN approval	€175.18	3	€134.75
120 x 80 x 93	BBG 1208R	4 wheels	€171.26	3	€131.74
120 x 100 x 79	BBG 1210	4 feet	€174.20	4	€134.00
120 x 100 x 79	BBG 1210K	3 skids	€191.98	4	€147.67
120 x 100 x 79	UN BBG 1210K	3 skids, UN approval	€198.95	4	€153.04
120 x 100 x 93	BBG 1210R	4 wheels	€195.82	4	€150.63
120 x 100 x 100	MBG 1210	4 feet	€231.38	2	€177.98
120 x 100 x 100	MBG 1210K	3 skids	€250.34	2	€192.57
120 x 100 x 114	MBG 1210R	4 wheels	€254.44	2	€195.72



***) only for orders placed via the online shop. Dispatch only on working days, provided the goods are in stock. Information regarding availability and current dispatch times can be found in the online shop.

BIG BOXES WITH VENTILATION SLITS



AVAILABLE UP FROM 1 PIECE
no minimum purchase order.

SPECIAL COLOURS
Simply order online

READY FOR DISPATCH
within **24** hours **

The foodstuffs giants

AUER Packaging's big box with ventilation slits is mainly used for the storage and transportation of foodstuffs, such as fruit and vegetables. Its smooth internal and external walls of tough, scratch-resistant plastic are easy to clean.

- Volume-optimised side walls
- Low empty weight
- Easy to clean

BIG BOXES WITH VENTILATION SLITS

RAL 7001

Outer dimensions L x W x H (cm)	Article No.	Design	Price for single unit	Units per stack on truck	Unit price on truck
80 x 60 x 79	BBO 86	4 feet	€88.54	6	€68.11
80 x 60 x 93	BBO 86R	4 wheels	€119.97	6	€92.29
120 x 100 x 79	BBO 1210	4 feet	€175.94	4	€135.34
120 x 100 x 79	BBO 1210K	3 skids	€194.90	4	€149.92
120 x 100 x 93	BBO 1210R	4 wheels	€199.00	4	€153.08
120 x 100 x 100	MBO 1210	4 feet	€217.97	2	€167.67
120 x 100 x 100	MBO 1210K	3 skids	€236.93	2	€182.25
120 x 100 x 114	MBO 1210R	4 wheels	€247.02	2	€190.01



***) only for orders placed via the online shop. Dispatch only on working days, provided the goods are in stock.
Information regarding availability and current dispatch times can be found in the online shop.

COLLAPSIBLE BIG BOXES WITH 4 OPENING FLAPS



AVAILABLE UP FROM 1 PIECE
no minimum purchase order.

SPECIAL COLOURS
Simply order online

READY FOR DISPATCH **24** hours**
within

Optimised handling

AUER Packaging's collapsible big box with 4 opening flaps offers ease and handling convenience: four flaps in the side walls provide quick and convenient access to the contents. When not in use or being returned empty, the side walls can be folded inwards to save space.

- Easy loading and unloading
- Height when folded: 42 cm
- Optional label holder

COLLAPSIBLE BIG BOXES WITH 4 OPENING FLAPS

RAL 7001

Outer dimensions L x W x H (cm)	Article No.	Design	Price for single unit	Units per stack on truck	Unit price on truck
80 x 60 x 79	KLK 86K	2 skids	€128.76	10	€99.05
80 x 60 x 93	KLK 86R	4 wheels	€176.72	10	€135.94
120 x 80 x 100	KLK 1208	4 feet	€267.48	5	€205.75
120 x 80 x 100	KLK 1208K	3 skids	€285.25	5	€219.43
120 x 80 x 114	KLK 1208R	4 wheels	€283.64	5	€218.18
120 x 80 x 114	KLK 1208KR	4 wheels, 3 skids	€301.41	5	€231.85
120 x 100 x 100	KLK 1210	4 feet	€291.63	5	€224.33
120 x 100 x 100	KLK 1210K	3 skids	€309.40	5	€238.00
120 x 100 x 114	KLK 1210R	4 wheels	€307.79	5	€236.76
120 x 100 x 114	KLK 1210KR	4 wheels, 3 skids	€325.56	5	€250.43

» Find ESD version on page 223



***) only for orders placed via the online shop. Dispatch only on working days, provided the goods are in stock. Information regarding availability and current dispatch times can be found in the online shop.

COLLAPSIBLE BIG BOXES SOLID



READY FOR DISPATCH **24** hours**
within

AVAILABLE UP FROM 1 PIECE
no minimum purchase order.

SPECIAL COLOURS
Simply order online

Unfolding their true potential

AUER Packaging's closed collapsible big box features volume-optimised side walls that can be folded inwards when it is empty. So you can make the best possible use of your storage and transport capacities, when the big box is full as well as when it's empty.

- Volume-optimised side walls
- Especially space-saving when empty
- Low empty weight
- Easy to clean

COLLAPSIBLE BIG BOXES SOLID

RAL 7001

Outer dimensions L x W x H (cm)	Article No.	Design	Price for single unit	Units per stack on truck	Unit price on truck
120 x 80 x 100	KLG 1208	4 feet	€238.10	5	€183.15
120 x 80 x 100	KLG 1208K	3 skids	€257.05	5	€197.73
120 x 80 x 114	KLG 1208R	4 wheels	€255.33	5	€196.41
120 x 80 x 114	KLG 1208KR	4 wheels, 3 skids	€274.29	5	€210.99
120 x 100 x 100	KLG 1210	4 feet	€266.27	5	€204.82
120 x 100 x 100	KLG 1210K	3 skids	€285.22	5	€219.40
120 x 100 x 114	KLG 1210R	4 wheels	€283.50	5	€218.08
120 x 100 x 114	KLG 1210KR	4 wheels, 3 skids	€302.46	5	€232.66
120 x 100 x 79	KSG 1210	4 feet	€239.07	5	€183.90
120 x 100 x 79	KSG 1210K	3 skids	€258.03	5	€198.48
120 x 100 x 93	KSG 1210R	4 wheels	€256.30	5	€197.15
120 x 100 x 93	KSG 1210KR	4 wheels, 3 skids	€275.26	5	€211.74

***) only for orders placed via the online shop. Dispatch only on working days, provided the goods are in stock.
Information regarding availability and current dispatch times can be found in the online shop.



COLLAPSIBLE BIG BOXES WITH VENTILATION SLITS

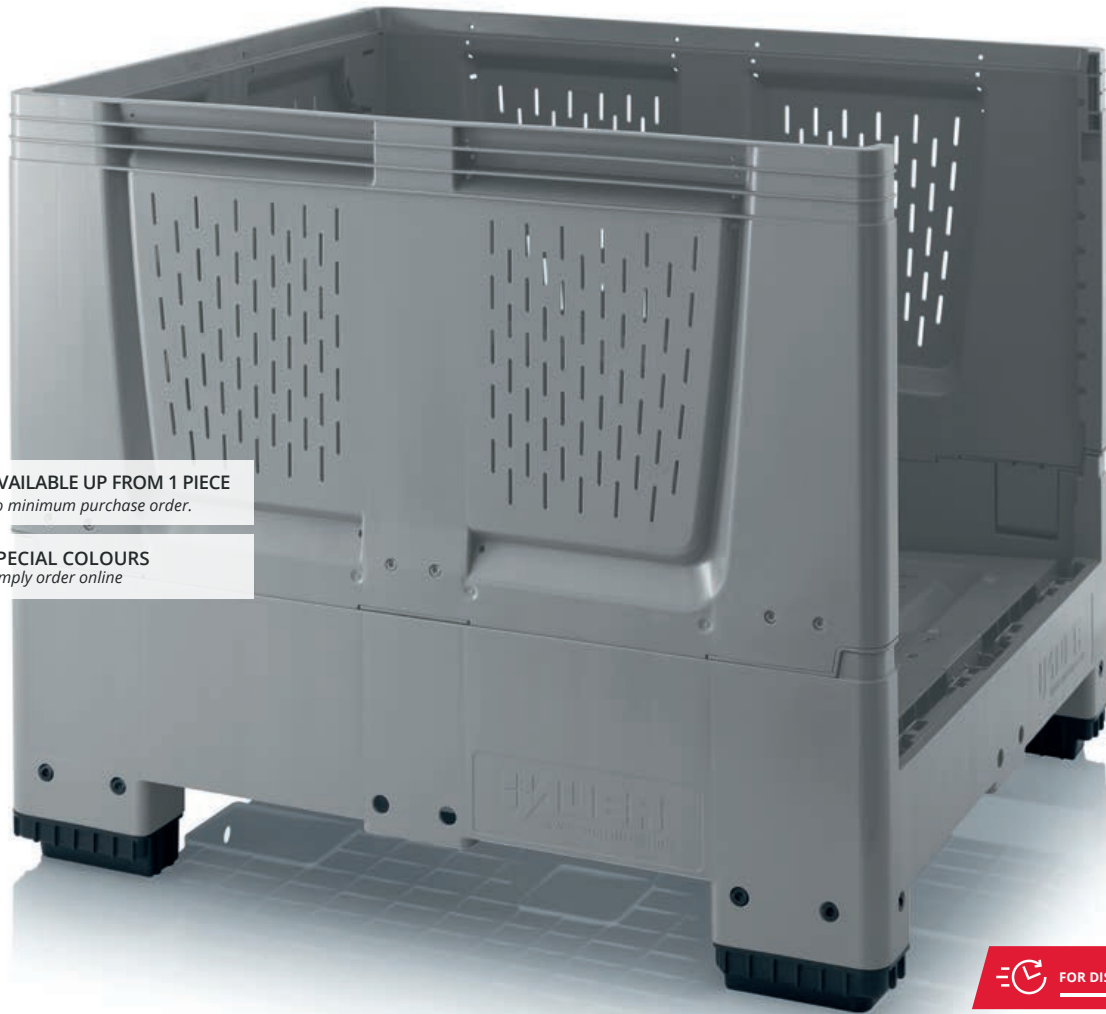

AVAILABLE UP FROM 1 PIECE
no minimum purchase order.

SPECIAL COLOURS
Simply order online

 **READY FOR DISPATCH** within **24 hours** **

Ergonomic transport

AUER Packaging's collapsible big box with ventilation slits is especially suitable for the storage and transportation of perishable goods due to the effectiveness of its ventilation slits. When not in use or being transported empty, the side walls can be folded inwards in a few simple steps in order to save space and costs.

- Ideal for transporting and storing foodstuffs
- With ventilation slits
- Volume-optimised side walls
- Product-friendly design

COLLAPSIBLE BIG BOXES WITH VENTILATION SLITS

RAL 7001

Outer dimensions L x W x H (cm)	Article No.	Design	Price for single unit	Units per stack on truck	Unit price on truck
120 x 80 x 100	KLO 1208	4 feet	€222.66	5	€171.27
120 x 80 x 100	KLO 1208K	3 skids	€241.62	5	€185.86
120 x 80 x 114	KLO 1208R	4 wheels	€239.89	5	€184.53
120 x 80 x 114	KLO 1208KR	4 wheels, 3 skids	€258.85	5	€199.11
120 x 100 x 100	KLO 1210	4 feet	€247.60	5	€190.46
120 x 100 x 100	KLO 1210K	3 skids	€266.56	5	€205.05
120 x 100 x 114	KLO 1210R	4 wheels	€264.84	5	€203.72
120 x 100 x 114	KLO 1210KR	4 wheels, 3 skids	€283.80	5	€218.30
120 x 100 x 79	KSO 1210	4 feet	€234.59	5	€180.45
120 x 100 x 79	KSO 1210K	3 skids	€253.55	5	€195.03
120 x 100 x 93	KSO 1210R	4 wheels	€251.82	5	€193.71
120 x 100 x 93	KSO 1210KR	4 wheels, 3 skids	€270.78	5	€208.29

***) only for orders placed via the online shop. Dispatch only on working days, provided the goods are in stock. Information regarding availability and current dispatch times can be found in the online shop.



FOLDABLE LARGE LOAD CARRIERS

AVAILABLE UP FROM 1 PIECE
no minimum purchase order.



Stable space-saving marvels

AUER Packaging's foldable large load carrier is extremely versatile: whether used as a food-safe hygienic container or a heat-insulating container, the large load carrier provides the best possible protection for its contents. To save costs during empty returns, the side walls can simply be folded down, reducing the volume tremendously.

- Ideal for transporting and storing foodstuffs
- Double-wall insulation
- Space-saving when empty
- Stackable with lid

FOLDABLE LARGE LOAD CARRIERS

RAL 7001

Outer dimensions L x W x H (cm)	Article No.	Design	Lid	Price for single unit	Units per stack on truck	Unit price on truck
80 x60 x81	GLT 86/83K	2 skids	no	€171.00	12	€131.54
80 x60 x89	GLT 86/83R	4 wheels	no	€254.20	12	€195.54
80 x60 x81	GLT 86/83RB	4 wheels with breaks	no	€262.52	12	€201.94
120 x80 x88	GLT 1208/91	4 feet	no	€292.84	5	€225.26
120 x80 x88	GLT 1208/91K	3 skids	no	€311.80	5	€239.85
120 x80 x88	GLT 1208/91R	4 wheels	no	€308.98	5	€237.68
120 x80 x88	GLT 1208/91RB	4 wheels with breaks	no	€314.97	5	€242.29
120 x100 x122	GLT 1210/125+D	4 feet	yes	€451.96	5	€347.66
120 x100 x122	GLT 1210/125	4 feet	no	€396.62	5	€305.09
120 x100 x122	GLT 1210/125K+D	3 skids	yes	€497.44	5	€382.64
120 x100 x122	GLT 1210/125K	3 skids	no	€442.09	5	€340.07
120 x100 x122	GLT 1210/125R+D	4 wheels	yes	€496.53	5	€381.95
120 x100 x122	GLT 1210/125R	4 wheels	no	€441.19	5	€339.38
120 x100 x122	GLT 1210/125RB+D	4 wheels with breaks	yes	€503.96	5	€387.66
120 x100 x122	GLT 1210/125RB	4 wheels with breaks	no	€448.62	5	€345.09



THE COMBINATION OPTIONS

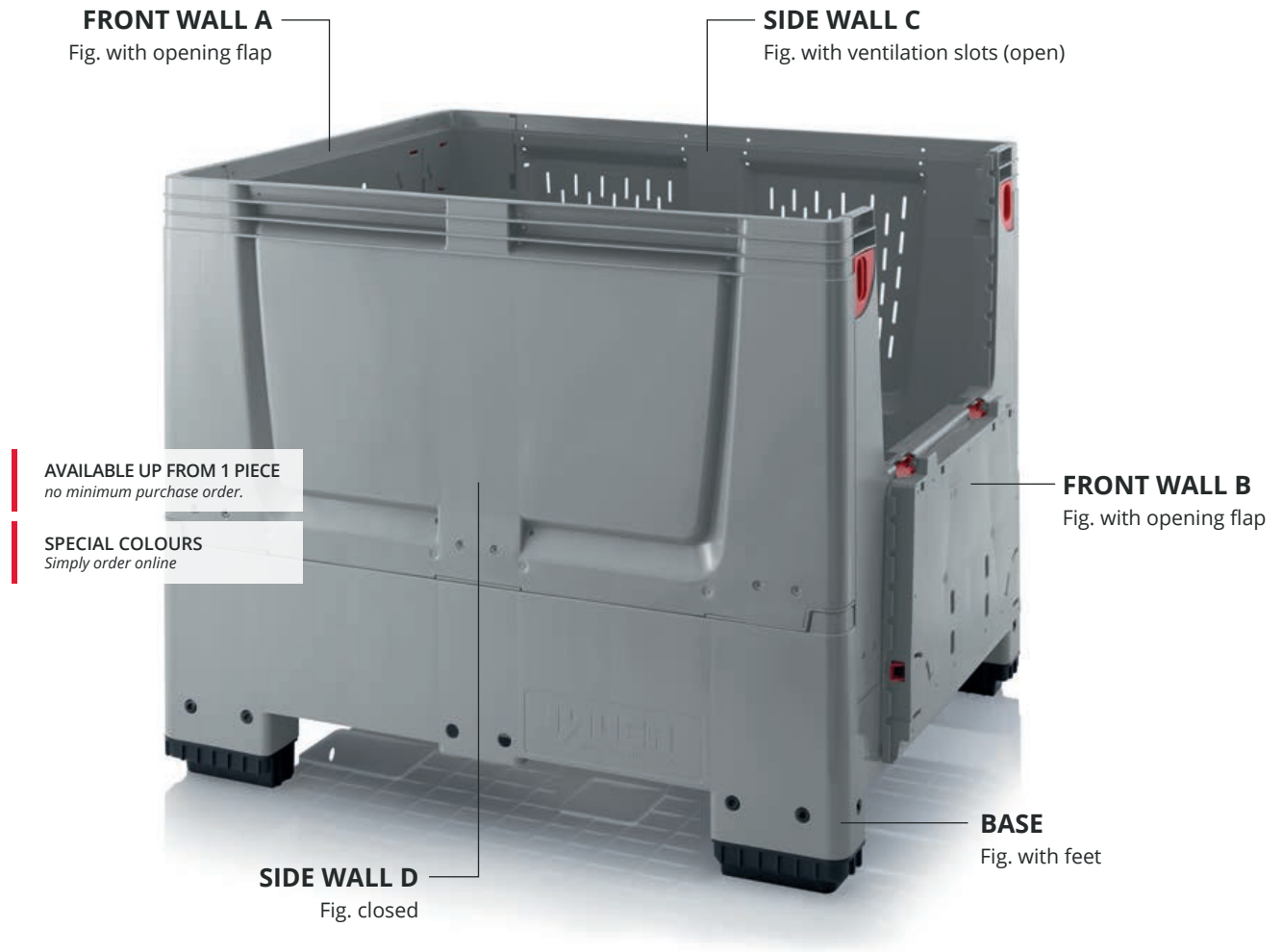

Tailor-made to suit you

AUER Packaging provides highly customised and flexible – and therefore highly attractive – combination options. You have the option of configuring the collapsible big box exactly according to your wishes: choose the right version for each individual side wall – regardless of whether it has an opening flap or is solid or whether it has ventilation slits.

- No extra costs
- Fully customised
- Also stackable with lid
- Optional accessories

THE COMBINATION OPTIONS

RAL 7001

Outer dimensions L x W x H (cm)	Article No.	Base design	Front wall	Side wall	Lower surface	Unit price
120 x 80 x 100	KLX G 1208 15 K	Closed	Closed / Closed	with ventilation slits / with ventilation slits	3 skids	€239.68
120 x 80 x 100	KLX O 1208 16 F	with ventilation slits	Closed / Closed	with ventilation slits / Cut-out flap	4 feet	€232.96
120 x 100 x 100	KLX G 1210 17 F	Closed	Closed / Closed	Cut-out flap / Closed	4 feet	€268.69
120 x 100 x 100	KLX O 1210 18 K	with ventilation slits	Closed / Closed	Cut-out flap / with ventilation slits	3 skids	€278.33



YOUR TAILOR-MADE BOXES!

YOUR ITEM NUMBER

KLX G 1210 13 K

BASE DESIGN

- G | solid
- O | open

SIZE (CM)

- 1208 | 120 x 80
- 1210 | 120 x 100

FRONT WALL A / B

- 1 | solid / solid
- 2 | solid / with ventilation slits
- 3 | solid / Cut-out flap
- 4 | with ventilation slits / solid
- 5 | with ventilation slits / with ventilation slits
- 6 | with ventilation slits / Cut-out flap
- 7 | Cut-out flap / solid
- 8 | Cut-out flap / with ventilation slits
- 9 | Cut-out flap / Cut-out flap

SIDE WALL C / D

- 1 | solid / solid
- 2 | solid / with ventilation slits
- 3 | solid / Cut-out flap
- 4 | with ventilation slits / solid
- 5 | with ventilation slits / with ventilation slits
- 6 | with ventilation slits / Cut-out flap
- 7 | Cut-out flap / solid
- 8 | Cut-out flap / with ventilation slits
- 9 | Cut-out flap / Cut-out flap

BASE LAYER

- F | 4 feet
- K | 3 skids

It's this easy!

- » Choose whether the bottom should be closed (C) or have ventilation slots (O).
- » Specify the size of the container (e.g. 1208 for 120 x 80 cm). The standard height is 100 cm.
- » To choose the finishes you want for the front and side walls, enter the numbers of the figures.
- » Choose between feet (F) and runners (R).

If you have any questions, please do not hesitate to contact us:

info@auer-packaging.com



ACCESSORIES

for pallet containers

Page 146 | Closing system SASC

Page 146 | Closing system SASV





ACCESSORIES PALLET CONTAINERS

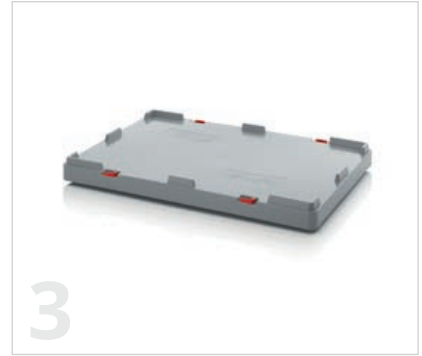
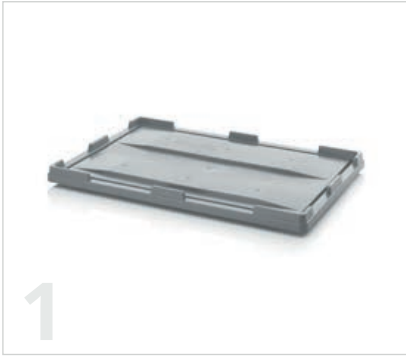

1 | PLACE-ON LIDS FOR BIG BOXES

RAL 7001

Suitable for basic dimension	Article No.	Price for single unit	Units per stack on truck	Unit price on truck
80 x60	DE 86 BB	€27.08	100	€20.83
120 x80	DE 1208 BB	€43.40	50	€33.39
120 x100	DE 1210 BB	€45.22	50	€34.78



2 | LID FOR IBC

RAL 7001

Suitable for basic dimension	Article No.	Price for single unit	Units per stack on truck	Unit price on truck
120 x 80	DE IBC 500	€57.47	25	€44.21
120 x 100	DE IBC 1000	€65.38	25	€50.29



3 | LID FOR LARGE LOAD CARRIERS

RAL 7001

Suitable for basic dimension	Article No.	Price for single unit	Units per stack on truck	Unit price on truck
80 x60	DE 86 GLT	€21.56	50	€16.59
120 x80	DE 1208 GLT	€52.07	25	€40.05
120 x100	DE 1210 GLT	€54.00	25	€41.54



LOCKING SYSTEMS FOR (FOLDABLE) BIG BOXES

Article No.	Design	Unit price
4 SASV	2 fixing hinges, 1 snap fastener, 1 padlock	€84.80
5 SASC	2 fixing hinges, 2 padlocks with eyebolts	€75.00
6 SC-Set	4 padlocks with eyebolts	€42.86
41132 2	Padlock Burg-Wächter, not attached	€4.92



SCREW CAP

Article No.	Design	Unit price
7	SST-1 Screw cap 1" suitable for Big Boxes	€5.35
8	SST-2 Screw cap 2" suitable for Big Boxes	€5.35



OUTLET VALVE 2" FOR BIG BOXES

Article No.	Design	Unit price
9	V2 Outlet valve 2" for Big Boxes	€15.95



WHEEL SET SUITABLE FOR BIG BOXES

Suitable for	Article No.	Description	Unit price
10 120 x 80 and 120 x 100	BBRA S1	4 steering wheels, including screws	€40.02
11 120 x 80 and 120 x 100	BBRA S2	2 steering wheels, 2 steering wheels with total locking devices, including screws	€43.51
120 x 80 and 120 x 100	BBRA S3	4 steering wheels with total locking devices, including screws	€46.99
10 BBG 86, BBO 86	BBRA S4	4 steering wheels, including screws	€29.51
11 BBG 86, BBO 86	BBRA S5	2 steering wheels, 2 steering wheels with total locking devices, including screws	€50.18
BBG 86, BBO 86	BBRA S6	4 steering wheels with total locking devices, including screws	€37.62

LABEL HOLDERS FOR FOLDABLE KLK BIG BOXES

RAL 3020

Outer dimensions L x W (cm)	Article No.	Suitable for	Unit price
12 25 x 15	ETA5	Collapsible big boxes with access doors	€2.11





IBC CONTAINERS

Hygienic and safe



IBC CONTAINERS WITH PLASTIC PALLET

AVAILABLE UP FROM 1 PIECE
no minimum purchase order.

READY FOR DISPATCH **24** hours**
within



The classic

AUER Packaging's IBC container is the ideal storage and transportation container for liquids of all kinds. The water tank has an impressive capacity of 1,000 litres and is exceptionally easy to use. For the transport of dangerous goods, an UN-approved version of the IBC container is also available.

- 1,000 litres volume
- Low tare weight fluctuations
- Reusable

IBC CONTAINERS WITH PLASTIC PALLET

Outer dimensions L x W x H (cm)	Article No.	Inlet	Outlet valve	UN approval	Price for single unit	Units per stack on truck	Unit price on truck
120 x 100 x 116	IBC 1000 K 150.50	NW 150	NW 50		€225.11	2	€173.16
120 x 100 x 116	IBC 1000 K 225.80	NW 225	NW 80		€231.10	2	€177.77
120 x 100 x 116	IBC 1000 K 150.50-UN	NW 150	NW 50	UN 31HA1/Y	€233.08	2	€179.29
120 x 100 x 116	IBC 1000 K 225.80-UN	NW 225	NW 80	UN 31HA1/Y	€239.11	2	€183.93



***) only for orders placed via the online shop. Dispatch only on working days, provided the goods are in stock.
Information regarding availability and current dispatch times can be found in the online shop.

FOLDABLE IBC / BAG IN BOX SYSTEM



AVAILABLE UP FROM 1 PIECE
no minimum purchase order.

Foldable for liquids

AUER Packaging's bag in box system provides maximum safety and hygiene with its replaceable liner bags. The reusable container protects the liquid contents and provides ideal transportation conditions due to its extremely resilient design. An antiseptic version of the liner bags can also be provided upon request.

- Reusable container
- Simple handling
- Hygiene – prevents decay
- Optimal use of space

FOLDABLE IBC / BAG IN BOX SYSTEM

RAL 7001

Outer dimensions L x W x H (cm)	Article No.	Design	Price for single unit	Units per stack on truck	Unit price on truck
120 x 80 x 91	IBC 500	Standard	€615.04	5	€473.11
120 x 100 x 125	IBC 1000	Standard	€779.72	5	€599.78
120 x 100 x 125	IBC 1000 EK	Front with cut-out handles with flaps	€818.55	5	€629.65



INLINER BAG AND ADAPTER

AVAILABLE UP FROM 1 PIECE
no minimum purchase order.



Safe and hygienic

AUER Packaging's replaceable liner bag provides maximum safety and hygiene. It is available in two versions: the standard version made of food-safe material, or as an aseptic, gamma-irradiated version. Both bags can be combined with a variety of different-sized filling openings, adapters and outlet valves.

- 250 l / 500 l / 1,000 l volumes
- Material 70 my Coes LDPE / Metalocene / LDPE
- Optionally gamma-irradiated
- Shape-welded liners

STANDARD LINER FOOD-SAFE

Volume	Article No.	Inlet	Outlet valve	Price for single unit	Units on pallet	Unit price on pallet
250 liter	INL 250A2E2	2" internal thread with closure	2" internal thread with closure	€13.66	300	€10.50
250 liter	INL 250V2E2	2" internal thread with closure	2" S60 external thread with valve	€17.07	300	€13.13
500 liter	INL 500A2E2	2" internal thread with closure	2" internal thread with closure	€24.87	180	€19.13
500 liter	INL 500V2E2	2" internal thread with closure	2" S60 external thread with valve	€26.73	180	€20.56
500 liter	INL 500A2E6	6" internal thread with closure	2" internal thread with closure	€27.75	180	€21.34
500 liter	INL 500V2E6	6" internal thread with closure	2" S60 external thread with valve	€37.94	180	€29.18
1,000 liter	INL 1000A2E2	2" internal thread with closure	2" internal thread with closure	€17.68	144	€13.60
1,000 liter	INL 1000V2E2	2" internal thread with closure	2" S60 external thread with valve	€31.82	144	€24.48
1,000 liter	INL 1000A2E6	6" internal thread with closure	2" internal thread with closure	€40.21	144	€30.93
1,000 liter	INL 1000V2E6	6" internal thread with closure	2" S60 external thread with valve	€43.33	144	€33.33
1,000 liter	INL 1000DN50E0		DN 50 external thread with valve	€32.30	144	€24.85



ASEPTIC LINERS GAMMA-IRRADIATED, INDIVIDUALLY PACKED IN STERILE BAGS

Volume	Article No.	Inlet	Outlet valve	Price for single unit	Units on pallet	Unit price on pallet
250 liter	A-INL 250A2E2	2" internal thread with closure	2" internal thread with closure	€23.27	300	€17.90
250 liter	A-INL 250V2E2	2" internal thread with closure	2" S60 external thread with valve	€23.41	300	€18.00
500 liter	A-INL 500A2E2	2" internal thread with closure	2" internal thread with closure	€32.97	180	€25.36
500 liter	A-INL 500V2E2	2" internal thread with closure	2" S60 external thread with valve	€35.79	180	€27.53
500 liter	A-INL 500A2E6	6" external thread with closure	2" internal thread with closure	€37.94	180	€29.18
500 liter	A-INL 500V2E6	6" external thread with closure	2" S60 external thread with valve	€41.35	180	€31.81
1,000 liter	A-INL 1000A2E2	2" internal thread with closure	2" internal thread with closure	€38.36	144	€29.50
1,000 liter	A-INL 1000V2E2	2" internal thread with closure	2" S60 external thread with valve	€36.60	144	€28.15
1,000 liter	A-INL 1000A2E6	6" external thread with closure	2" internal thread with closure	€41.67	144	€32.05
1,000 liter	A-INL 1000V2E6	6" external thread with closure	2" S60 external thread with valve	€51.03	144	€39.25
1,000 liter	A-INL 1000DN50E0		DN 50 external thread with valve	€51.52	144	€39.63



ACCESSORIES IBC CONTAINERS



ADAPTER WITH SEAL

Article No.	Type	From	To	Unit price
1 A1	Adapter	2" S60 external thread	2" BSP	€11.62
2 A2	Adapter	2" S60 external thread	2" Male Cam	€11.60
3 A3	Adapter	2" S60 external thread	2" Tri-Clamp	€11.62
4 A4	Adapter	2" S60 external thread	DN 50 dairy fitting	€11.60
5 A5	Adapter	2" internal thread	DN 50 dairy fitting	€63.44
6 A6	Adapter	2" internal thread	2" external thread	€69.79
7 V50	Butterfly valve	2" internal thread	2" internal thread	€101.47



IBC FILLING BRIDGE

Article No.	Suitable for	Unit price
8 IBC BB 500 2	IBC 500 / INL with 2" inlet	€169.71
9 BB IBC 6.2	INL with 6" inlet	€320.83

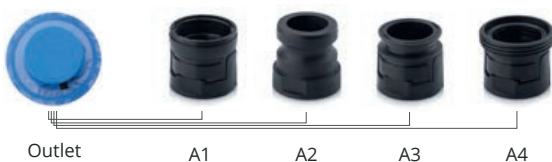

Outlet
2" S60
male thread



Outlet
2" female thread

BAG-IN-BOX IBC

AVAILABLE UP FROM 1 PIECE
no minimum purchase order.



Hygienic storage of liquids

The bag-in-box IBC, with its interchangeable low-price liner bags, is the economic solution for storing and transporting liquid contents. Thanks to its robust design, the IBC container can hold 250, 500 or 600 litres, depending on the model. Unlike the foldable IBC/bag-in-box system, it is used when there is no requirement to save space when transporting the container with an empty load and when the container can be filled and emptied from above.

- Returnable container
- Easy to use and clean thanks to smooth walls
- Hygienic model
- Integrated, permanently affixed filling aid
- Optionally with skids or feet

BAG-IN-BOX IBC

RAL 7001

Article No.	Outer dimensions L x W x H (cm)	Volume	Design	Unit price on pallet	Price for single unit
BIB IBC 250	80 x 60 x 79	250 liter	4 feet	€329.51	€428.36
BIB IBC 500	120 x 80 x 79	535 liter	4 feet	€417.38	€542.59
BIB IBC 600	120 x 100 x 79	670 liter	4 feet	€455.69	€592.40
BIB IBC 500K	120 x 80 x 79	535 liter	3 skids	€431.05	€560.37
BIB IBC 600K	120 x 100 x 79	670 liter	3 skids	€469.36	€610.17



STANDARD LINER FOOD-SAFE

AVAILABLE UP FROM 1 PIECE
no minimum purchase order.



Simply tight

The replaceable inliner for the bag-in-box IBC provides maximum security. It is made of food-safe material and is equipped with a valve on the top that can be used for draining purposes.

- 250 / 500 / 600 litre volume
- Material 70 µm Coex LDPE
- Form-welded inliner

STANDARD LINER FOOD-SAFE

Volume	Article No.	Inlet	Price for single unit	Units on pallet	Unit price on pallet
250 liter	INL 250A0E2	2" internal thread with closure	€17.07	300	€13.13
500 liter	INL 500A0E2	2" internal thread with closure	€15.46	180	€11.89
600 liter	INL 600A0E2	2" internal thread with closure	€15.46	180	€11.89



TRANSPORTATION AIDS

—
Maximum mobility





COMPACT TRANSPORT TROLLEYS 60 x 40 cm

AVAILABLE UP FROM 1 PIECE
no minimum purchase order.

SPECIAL COLOURS
Simply order online

READY FOR DISPATCH within **24 hours** **



The rolling classic

AUER Packaging's transport trolley makes light work of moving plastic containers from A to B. Its basic dimensions of 60x40 cm also make it possible to transport two 40x30 cm containers. You have the choice of rubber or polyamide wheels, fixed or swivel wheels as well as an optional parking brake and thread guard.

» Find ESD version on page 207

- High-quality, smooth-running wheels
- Available in various designs
- Very stable, 250 kg load-bearing capacity
- Matched to Euro dimensions

COMPACT TRANSPORT TROLLEYS WITH RUBBER WHEELS 60 x 40 cm

Outer dimensions L x W (cm)	Article No.	Article No.	Design Castors	Price for single unit	Units on pallet	Unit price on pallet
62 x 42	RO 64.4 GU-3020	RO 64.4 GU-5015	4 steering castors	€30.93	80	€23.80
62 x 42	RO 64.4 GU BO-3020	RO 64.4 GU BO-5015	2 steering castors, 2 fixed castors	€32.72	80	€25.17
62 x 42	RO 64.4 GU FA-3020	RO 64.4 GU FA-5015	4 steering castors with thread guard	€33.20	80	€25.54
62 x 42	RO 64.4 GU FE-3020	RO 64.4 GU FE-5015	2 steering castors, 2 steering castors with wheel stop	€40.55	80	€31.19



COMPACT TRANSPORT TROLLEYS WITH POLYAMIDE WHEELS 60 x 40 cm

Outer dimensions L x W (cm)	Article No.	Article No.	Design Castors	Price for single unit	Units on pallet	Unit price on pallet
62 x 42	RO 64.4 PA-3020	RO 64.4 PA-5015	4 steering castors	€32.81	80	€25.24
62 x 42	RO 64.4 PA BO-3020	RO 64.4 PA BO-5015	2 steering castors, 2 fixed castors	€32.02	80	€24.63
62 x 42	RO 64.4 PA FE-3020	RO 64.4 PA FE-5015	2 steering castors, 2 steering castors with wheel stop	€38.09	80	€29.30
62 x 42	RO 64.4 PAX-3020	RO 64.4 PAX-5015	4 stainless steel steering castors	€72.82	80	€56.01
62 x 42	RO 64.4 PAX BO-3020	RO 64.4 PAX BO-5015	2 stainless steel steering castors, 2 stainless steel fixed castors	€86.40	80	€66.46



STANDARD COLOURS



RAL 3020
traffic red



RAL 5015
sky blue

**) only for orders placed via the online shop. Dispatch only on working days, provided the goods are in stock. Information regarding availability and current dispatch times can be found in the online shop.

COMPACT HD TRANSPORT TROLLEY 60 x 40 cm

AVAILABLE UP FROM 1 PIECE
no minimum purchase order.



The weightlifter

With AUER Packaging's compact HD transport trolley, you can fill your plastic containers with heavy loads and still transport them easily from point A to point B. The basic dimensions of 60 cm x 40 cm also allow you to transport two containers measuring 40 cm x 30 cm. With rubber or polyamide wheels, fixed wheels or swivel wheels, optional wheel stop or thread guard.

- Steel tube-reinforced version
- Extremely impressive load capacity of 350 kg
- High-quality, smooth-rolling wheels
- Aligned with Euro dimensions

COMPACT HD TRANSPORT TROLLEY WITH RUBBER WHEELS 60 x 40 cm

Outer dimensions L x W (cm)	Article No.	Article No.	Design Castors	Unit price on pallet	Units per pallet	Price for single unit
62 x 42	RO 64.4 HD GU-3020	RO 64.4 HD GU-5015	4 steering castors	€25.61	80	€33.29
62 x 42	RO 64.4 HD GU BO-3020	RO 64.4 HD GU BO-5015	2 steering castors, 2 fixed castors	€26.98	80	€35.08
62 x 42	RO 64.4 HD GU FA-3020	RO 64.4 HD GU FA-5015	4 steering castors with thread guard	€27.35	80	€35.56
62 x 42	RO 64.4 HD GU FE-3020	RO 64.4 HD GU FE-5015	2 steering castors, 2 steering castors with wheel stop	€33.01	80	€42.91



COMPACT HD TRANSPORT TROLLEY WITH POLYAMIDE WHEELS 60 x 40 cm

Outer dimensions L x W (cm)	Article No.	Article No.	Design Castors	Unit price on pallet	Units per pallet	Price for single unit
62 x 42	RO 64.4 HD PA-3020	RO 64.4 HD PA-5015	4 steering castors	€27.05	80	€35.17
62 x 42	RO 64.4 HD PA BO-3020	RO 64.4 HD PA BO-5015	2 steering castors, 2 fixed castors	€26.44	80	€34.37
62 x 42	RO 64.4 HD PA FE-3020	RO 64.4 HD PA FE-5015	2 steering castors, 2 steering castors with wheel stop	€31.11	80	€40.45
62 x 42	RO 64.4 HD PAX-3020	RO 64.4 HD PAX-5015	4 stainless steel steering castors	€65.34	80	€84.95
62 x 42	RO 64.4 HD PAX BO-3020	RO 64.4 HD PAX BO-5015	2 stainless steel steering castors, 2 stainless steel fixed castors	€75.78	80	€98.52



MAXI HD TRANSPORT TROLLEY 80 x 60 cm



The large stackable version

AUER Packaging's new generation of Maxi transport trolleys can not just carry large plastic containers with basic dimensions of 80 cm x 60 cm: The board has also been designed that two containers measuring 60 cm x 40 cm or four containers measuring 40 cm x 30 cm can be safely placed next to each other.

Another new option: In addition to the steel tube reinforcement, which also features in the basic version, an ultra-strong heavy duty version with an additional pair of swivel castors is available. Thanks to the sturdy support in the middle, the Maxi transport trolley with six castors can handle a load capacity of 500 kg.

- Optionally available with 4 or 6 castors
- Extremely impressive load capacity of 250 kg or 500 kg
- Aligned with Euro dimensions
- High-quality, smooth-rolling wheels

» ESD version available in our online shop

MAXI HD TRANSPORT TROLLEY WITH RUBBER WHEELS 80 x 60 cm

Outer dimensions L x W (cm)	Article No.	Article No.	Design Castors	Price for single unit	Units per pallet	Unit price on pallet
82 x 62	RO 86.4 HD GU-3020	RO 86.4 HD GU-5015	Four steering castors	€84.01	26	€64.62
82 x 62	RO 86.4 HD GU BO-3020	RO 86.4 HD GU BO-5015	2 steering castors, 2 fixed castors	€83.06	26	€63.89
82 x 62	RO 86.4 HD GU FA-3020	RO 86.4 HD GU FA-5015	4 steering castors with thread guard	€85.63	26	€65.87
82 x 62	RO 86.4 HD GU FE-3020	RO 86.4 HD GU FE-5015	2 steering castors, 2 steering castors with wheel stop	€86.10	26	€66.23
82 x 62	RO 86.6 HD GU-3020	RO 86.6 HD GU-5015	6 swivel wheels	€95.54	26	€73.49
82 x 62	RO 86.6 HD GU BO-3020	RO 86.6 HD GU BO-5015	4 swivel wheels, 2 fixed wheels	€94.55	26	€72.73
82 x 62	RO 86.6 HD GU FA-3020	RO 86.6 HD GU FA-5015	6 swivel wheels with thread guard	€97.97	26	€75.36
82 x 62	RO 86.6 HD GU FE-3020	RO 86.6 HD GU FE-5015	4 swivel wheels, 2 swivel wheels wheel stop	€97.63	26	€75.10



STANDARD COLOURS



RAL 3020
traffic red



RAL 5015
sky blue

AVAILABLE UP FROM 1 PIECE
no minimum purchase order.

SPECIAL COLOURS
Simply order online



MAXI HD TRANSPORT TROLLEY WITH POLYAMIDE WHEELS 80 x 60 cm

Outer dimensions L x W (cm)	Article No.	Article No.	Design Castors	Price for single unit	Units per pallet	Unit price on pallet
82 x 62	RO 86.4 HD PA-3020	RO 86.4 HD PA-5015	Four steering castors	€82.79	26	€63.69
82 x 62	RO 86.4 HD PA BO-3020	RO 86.4 HD PA BO-5015	2 steering castors, 2 fixed castors	€81.64	26	€62.80
82 x 62	RO 86.4 HD PA FE-3020	RO 86.4 HD PA FE-5015	2 steering castors, 2 steering castors with wheel stop	€85.29	26	€65.61
82 x 62	RO 86.4 HD PAX-3020	RO 86.4 HD PAX-5015	4 stainless steel steering castors	€188.87	26	€145.29
82 x 62	RO 86.4 HD PAX BO-3020	RO 86.4 HD PAX BO-5015	2 stainless steel steering castors, 2 stainless steel fixed castors	€202.74	26	€155.96
82 x 62	RO 86.6 HD PA-3020	RO 86.6 HD PA-5015	6 swivel wheels	€93.71	26	€72.09
82 x 62	RO 86.6 HD PA BO-3020	RO 86.6 HD PA BO-5015	4 swivel wheels, 2 fixed wheels	€92.52	26	€71.17
82 x 62	RO 86.6 HD PA FE-3020	RO 86.6 HD PA FE-5015	4 swivel wheels, 2 swivel wheels wheel stop	€96.21	26	€74.01
82 x 62	RO 86.6 HD PAX-3020	RO 86.6 HD PAX-5015	6 stainless steel swivel wheels	€254.66	26	€195.89
82 x 62	RO 86.6 HD PAX BO-3020	RO 86.6 HD PAX BO-5015	4 stainless steel swivel wheels, 2 stainless steel fixed wheels	€268.53	26	€206.56



HAND TROLLEY MULTI-PURPOSE



Safely transported

AUER Packaging's multi-purpose hand trolley is a versatile aid for moving heavy loads. Its sturdy metal platform enables you to transport even bulky goods easily from A to B. Its ergonomic design enhances operator comfort during handling.

- Ergonomic
- Multi-purpose
- Carrying capacity up to 160 kg
- Especially smooth-running wheels

HAND TROLLEY MULTI-PURPOSE

RAL 7016

Article No.	Design	Carrying load	Price for single unit	Units on pallet	Unit price on pallet
1 SK U	without height adjustment	160 kg	€239.16	12	€183.97
2 SK V U	with height adjustment	160 kg	€270.67	12	€208.21

STACKING TROLLEYS FOR COMPACT TRANSPORT TROLLEYS



AVAILABLE UP FROM 1 PIECE
no minimum purchase order.

Space-saving storage

AUER Packaging's transport trolley stacker trolley holds up to 15 stacked compact transport trolleys in a tight space. Thanks to four smooth-running castors with Santoprene thermoplastic rubber treads, the stacker trolley moves smoothly and quietly.

- Stainless steel frame
- Up to 15 AUER transport trolleys can be stacked
- Manoeuvrable and quiet
- 4 smooth-running castors

STACKING TROLLEYS FOR COMPACT TRANSPORT TROLLEYS

Outer dimensions L x W x H (cm)	Article No.	Price for single unit	Units on pallet	Unit price on pallet
60 x 41 x 118	SW RO	€277.14	10	€213.19

WHEELS



SWIVEL CASTOR

Article No.	Suitable for	Wheel Ø x wheel width (cm)	Bracket made of	Design wheel	Total lock brake	Thread guard	Price for single items
1	RO 64.4, RO 86.4, RO 86.6	10 x 3.0	galvanised steel	Rubber wheel, grey	no	no	€3.44
2	RO 64.4, RO 86.4, RO 86.6	10 x 3.0	galvanised steel	Rubber wheel, grey	no	yes	€3.20
3	RO 64.4, RO 86.4, RO 86.6	10 x 3.4	galvanised steel	Plastic wheel, original	no	no	€3.10
4	RO 64.4, RO 86.4, RO 86.6	10 x 2.7	Stainless steel, polished	Plastic wheel, original	no	no	€12.93
5	RO 64.4, RO 86.4, RO 86.6	10 x 3.0	galvanised steel	Plastic wheel, black	no	no	€5.93
6	RO 86	12.5 x 3.8	galvanised steel	Rubber wheel, black	no	no	€4.52
7	RO 86	12.5 x 3.8	galvanised steel	Rubber wheel, black	no	yes	€5.69
8	RO 86	12.5 x 3.4	galvanised steel	Plastic wheel, original	no	no	€4.45
9	RO 86	12.5 x 3.4	galvanised steel	Plastic wheel, original	no	yes	€5.23
10	RO 86	12.5 x 3.4	Stainless steel	Plastic wheel, original	no	no	€15.54
11	Big boxes 120 x 80 and 120 x 100	10.0 x 3.0	galvanised steel	Rubber wheel, grey	no	no	€9.67
12	Big boxes 120 x 80 and 120 x 100	10.0 x 3.0	Stainless steel, polished	Rubber wheel, grey	no	no	€39.33
13	Big boxes 120 x 80 and 120 x 100	12.5 x 3.4	galvanised steel	Plastic wheel, original	no	no	€10.10
14	Stacking trolleys	7.5 x 2.4	galvanised steel	Rubber wheel, grey	no	no	€1.68



ESD WHEELS

Article No.	Suitable for	Wheel Ø x wheel width (cm)	Bracket made of	Design wheel	Total lock brake	Thread guard	Price for single items
16	RO 64.4, RO 86.4, RO 86.6	10 x 3.0	galvanised steel	ESD rubber wheel, black	no	no	€4.47
17	RO 64.4, RO 86.4, RO 86.6	10 x 3.0	galvanised steel	ESD rubber wheel, black	yes	no	€6.54
18	ESD RO 86	12.5 x 3.4	galvanised steel	ESD plastic wheel, black	no	no	€7.29
19	Big boxes 120 x 80 and 120 x 100	10.0 x 3.0	galvanised steel	ESD rubber wheel, black	no	no	€9.17
20	Big boxes 120 x 80 and 120 x 100	10.0 x 3.0	galvanised steel	ESD rubber wheel, black	yes	no	€11.25



SWIVEL CASTOR WITH BRAKE

Article No.	Suitable for	Wheel Ø x wheel width (cm)	Bracket made of	Design wheel	Total lock brake	Thread guard	Price for single items
21	RO 64.4, RO 86.4, RO 86.6	10 x 3.0	galvanised steel	Rubber wheel, grey	yes	no	€7.44
22	RO 64.4, RO 86.4, RO 86.6	10 x 3.0	galvanised steel	Rubber wheel, grey	yes	yes	€6.71
23	RO 64.4, RO 86.4, RO 86.6	10 x 3.4	galvanised steel	Plastic wheel, original	yes	no	€5.74
24	RO 64.4, RO 86.4, RO 86.6	10 x 3.0	Stainless steel, polished	Plastic wheel, original	yes	no	€15.23
25	RO 86	12.5 x 3.8	galvanised steel	Rubber wheel, black	yes	no	€7.72
26	RO 86	12.5 x 3.4	galvanised steel	Plastic wheel, original	yes	no	€6.15
27	Big boxes 120 x 80 and 120 x 100	10.0 x 3.0	galvanised steel	Rubber wheel, grey	yes	no	€11.41
28	Big boxes 120 x 80 and 120 x 100	12.5 x 3.4	galvanised steel	Plastic wheel, original	yes	no	€13.66
29	System trolleys	7.5 x 2.4	galvanised steel	Rubber wheel, grey	yes	no	€2.16



RIGID CASTOR

Article No.	Suitable for	Wheel Ø x wheel width (cm)	Bracket made of	Design wheel	Total lock brake	Thread guard	Price for single items
30	RO 64.4, RO 86.4, RO 86.6	10 x 2.7	Stainless steel, polished	Plastic wheel, original	no	no	€15.72
31	RO 64.4, RO 86.4, RO 86.6	10 x 3.4	galvanised steel	Plastic wheel, black	no	no	€4.52
32	RO 86	12.5 x 3.8	galvanised steel	Rubber wheel, black	no	no	€4.13
33	RO 86	12.5 x 3.8	galvanised steel	Rubber wheel, black	no	yes	€5.30
34	RO 86	12.5 x 3.4	galvanised steel	Plastic wheel, original	no	no	€3.49
35	RO 86	12.5 x 3.4	galvanised steel	Plastic wheel, original	no	yes	€3.96
36	RO 86	12.5 x 3.4	Stainless steel	Plastic wheel, original	no	no	€9.03

SYSTEM TROLLEYS

Tidiness on the move





SYSTEM TROLLEYS FOR RACK BOXES



AVAILABLE UP FROM 1 PIECE
no minimum purchase order.

For optimised work processes

AUER Packaging's system trolley for rack boxes is outstandingly simple to use. The rack and material flow boxes are simply suspended in the aluminium profile system which has been precisely configured for that purpose. Everything you need for your operations is always exactly where you need it to be – and perfectly sorted too.

- Stable aluminium profile
- High load-bearing capacity
- Lockable easy running rollers

» Find ESD version on page 208



SYSTEM TROLLEYS FOR RACK BOXES UNLOADED

	Dimensions W x D x H (cm)	Article No.	Design	Equipment	Unit price
1	112 x 65 x 135	SR.L	one-sided	Unloaded (suitable for rack boxes 9 cm high)	€515.55
2	112 x 65 x 135	SR.L.214	one-sided	Unloaded (suitable for rack boxes 14 cm high)	€515.55



SYSTEM TROLLEYS FOR RACK BOXES SHELF DEPTH 30 cm

	Dimensions W x D x H (cm)	Article No.	Design	Equipment	Unit price
3	112 x 65 x 135	SR.L.3109	one-sided	56 x RK 3109 (30 x 11,7 x 9 cm)	€616.02
4	112 x 65 x 135	SR.L.31509	one-sided	42 x RK 31509 (30 x 15,6 x 9 cm)	€592.53
5	112 x 65 x 135	SR.L.3209	one-sided	28 x RK 3209 (30 x 23,4 x 9 cm)	€577.25
6	112 x 65 x 135	SR.L.3214	one-sided	20 x RK 3214 (30 x 23,4 x 14 cm)	€569.37



SYSTEM TROLLEYS FOR RACK BOXES SHELF DEPTH 40 cm

	Dimensions W x D x H (cm)	Article No.	Design	Equipment	Unit price
3	112 x 65 x 135	SR.L.4109	one-sided	56 x RK 4109 (40 x 11,7 x 9 cm)	€625.85
4	112 x 65 x 135	SR.L.41509	one-sided	42 x RK 41509 (40 x 15,6 x 9 cm)	€602.37
5	112 x 65 x 135	SR.L.4209	one-sided	28 x RK 4209 (40 x 23,4 x 9 cm)	€583.80
6	112 x 65 x 135	SR.L.4214	one-sided	20 x RK 4214 (40 x 23,4 x 14 cm)	€574.05



SYSTEM TROLLEYS FOR RACK BOXES SHELF DEPTH 50 cm

	Dimensions W x D x H (cm)	Article No.	Design	Equipment	Unit price
3	112 x 65 x 135	SR.L.5109	one-sided	56 x RK 5109 (50 x 11,7 x 9 cm)	€646.59
4	112 x 65 x 135	SR.L.51509	one-sided	42 x RK 51509 (50 x 15,6 x 9 cm)	€620.39
5	112 x 65 x 135	SR.L.5209	one-sided	28 x RK 5209 (50 x 23,4 x 9 cm)	€596.36
6	112 x 65 x 135	SR.L.5214	one-sided	20 x RK 5214 (50 x 23,4 x 14 cm)	€583.02



SYSTEM TROLLEYS FOR TIPPING BOXES

AVAILABLE UP FROM 1 PIECE
no minimum purchase order.



Full transparency

Thanks to its tippable, transparent containers, AUER Packaging's system trolley for tipping boxes makes it easy to keep tabs on its contents – and to access individual items – at any time. Different tipping box modules can be combined at will. When ordering, you can choose whether the system trolley is to be able to be loaded on one side or both sides.

- Stable aluminium profile
- High load-bearing capacity
- Lockable easy running rollers
- Can be loaded on both sides depending on the design



SYSTEM TROLLEYS FOR TIPPING BOXES

	Dimensions W x D x H (cm)	Article No.	Design	Equipment	Unit price
1	69 x 45 x 134	SK.L	one-sided	unloaded	€218.93
2	69 x 68 x 134	SK.T	double-sided	unloaded	€229.88
3	69 x 45 x 134	SK.L.GB	one-sided	1 x KKS 9 t, 3 x KKS 6 t, 2 x KKS 5 t, 1 x KKS 4 t, 1 x KKS 3 t	€335.64
4	69 x 68 x 134	SK.T.GB	double-sided	2 x KKS 9 t, 6 x KKS 6 t, 4 x KKS 5 t, 2 x KKS 4 t, 2 x KKS 3 t	€463.29
5	69 x 45 x 134	SK.L.9	one-sided	15 x KKS 9 t	€365.18
6	69 x 45 x 134	SK.L.6	one-sided	10 x KKS 6 t	€327.93
7	69 x 45 x 134	SK.L.5	one-sided	7 x KKS 5 t	€333.86
8	69 x 45 x 134	SK.L.4	one-sided	5 x KKS 4 t	€315.26
9	69 x 45 x 134	SK.L.3	one-sided	5 x KKS 3 t	€329.69
10	69 x 45 x 134	SK.L.2	one-sided	3 x KKS 2 t	€335.34
	69 x 68 x 134	SK.T.9	double-sided	30 x KKS 9 t	€522.38
	69 x 68 x 134	SK.T.6	double-sided	20 x KKS 6 t	€447.89
	69 x 68 x 134	SK.T.5	double-sided	14 x KKS 5 t	€459.74
	69 x 68 x 134	SK.T.4	double-sided	10 x KKS 4 t	€422.54
	69 x 68 x 134	SK.T.3	double-sided	10 x KKS 3 t	€451.40
	69 x 68 x 134	SK.T.2	double-sided	6 x KKS 2 t	€474.45



SYSTEM TROLLEYS FOR EURO CONTAINERS 60 x 40 cm HEIGHT 134 cm

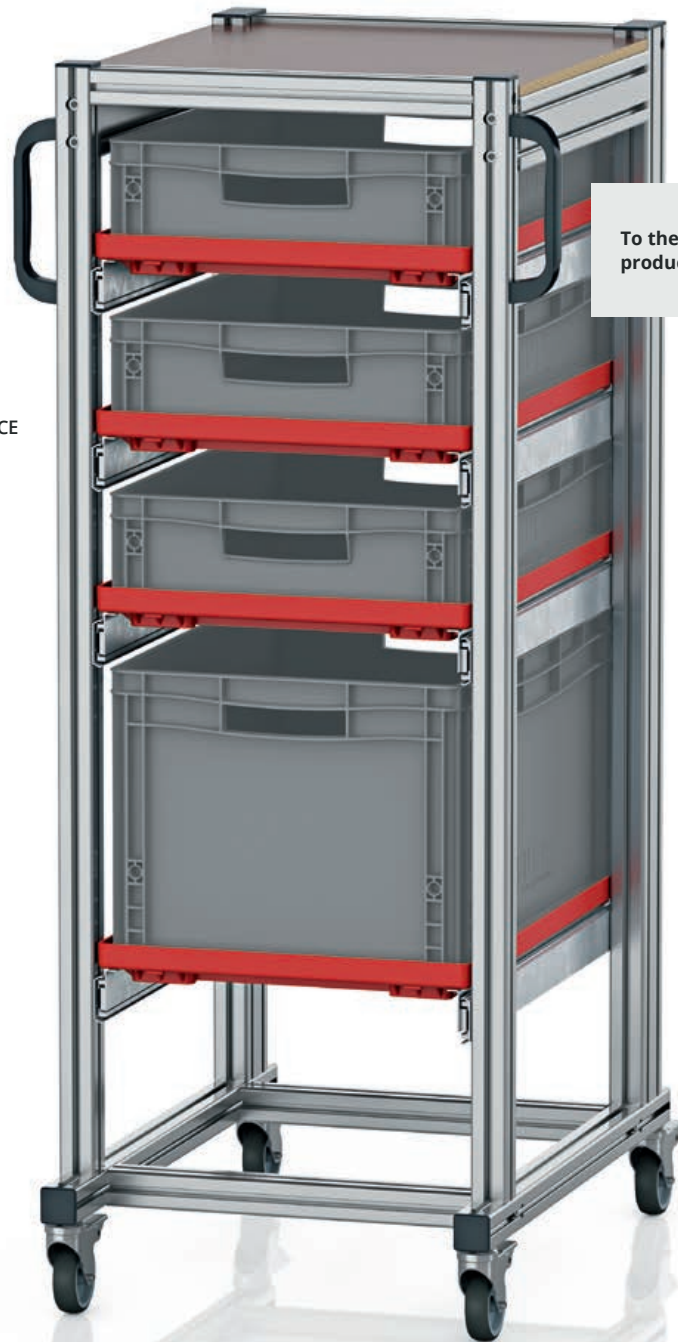

AVAILABLE UP FROM 1 PIECE
no minimum purchase order.

To the
product video:



6

Tidiness on the move

AUER Packaging's system trolley for Euro containers is the ideal solution if the contents of several Euro containers is frequently required at different work stations. This system trolley removes the need for laborious reloading onto pallets for transport and the need to carry items by hand.

- Stable aluminium profile
- High load-bearing capacity
- Lockable easy running rollers
- Easy to move, even when loaded

» Find ESD version on page 210



SYSTEM TROLLEYS FOR EURO CONTAINERS 60 x 40 cm HEIGHT 134 cm

	Outer dimensions L x W x H (cm)	Article No.	Design	Equipment	Price for single unit
1	72 x 50 x 135	SE 134 64 U.2	one-sided	5 x full extension	€847.94
2	72 x 50 x 135	SE 134 6475.2	one-sided	6 x full extension, 6 x EG 64/75 HG	€945.58
3	72 x 50 x 135	SE 134 6412.2	one-sided	5 x full extension, 5 x EG 64/12	€886.25
4	72 x 50 x 135	SE 134 6417.2	one-sided	4 x full extension, 4 x EG 64/17	€824.71
5	72 x 50 x 135	SE 134 6422.2	one-sided	3 x full extension, 3 x EG 64/22	€760.93
6	72 x 50 x 135	SE 134 6432.2	one-sided	4 x full extension, 3 x EG 64/12, 1 x EG 64/32	€825.59
7	72 x 50 x 135	SE 134 6442.2	one-sided	2 x full extension, 2 x EG 64/42	€704.98

SYSTEM TROLLEYS FOR EURO CONTAINERS 60 x 40 cm HEIGHT 200 cm

AVAILABLE UP FROM 1 PIECE
no minimum purchase order.

To the
product video:



6

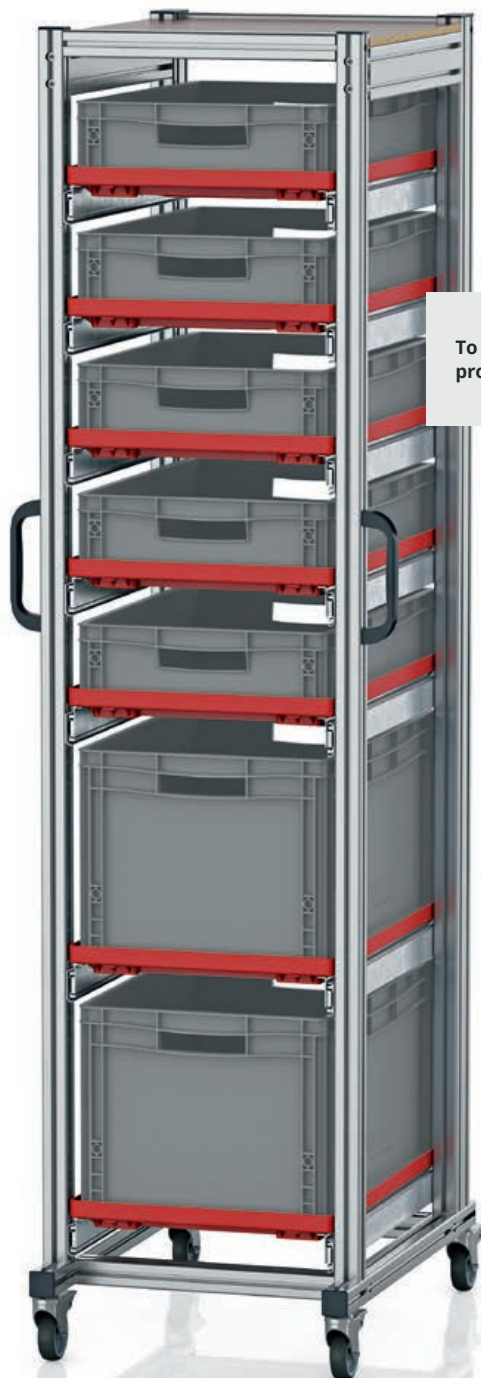

Mobile organisation in XL-format

The 200-centimetre-high system trolley for Euro containers made by AUER Packaging is the ideal solution when the content of a very large number of Euro containers is continuously required at different work stations. With the help of this system trolley, there is no need for the laborious task of reloading the content onto pallets for transportation purposes or for carrying loads by hand.

- Stable aluminium profile
- High load-bearing capacity
- Extra high model
- Lockable easy running rollers
- Easy to move, even when loaded

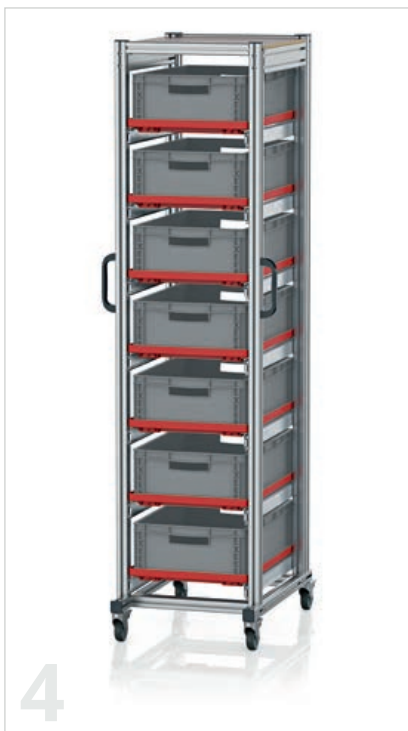

SYSTEM TROLLEYS FOR EURO CONTAINERS 60 x 40 cm HEIGHT 200 cm

	Outer dimensions L x W x H (cm)	Article No.	Design	Equipment	Price for single unit
1	72 x 50 x 201	SE 200 64 U.2	one-sided	6 x full extension	€941.46
2	72 x 50 x 201	SE 200 6475.2	one-sided	12 x full extension, 12 x EG 64/75 HG	€1,371.00
3	72 x 50 x 201	SE 200 6412.2	one-sided	9 x full extension, 9 x EG 64/12	€1,186.00
4	72 x 50 x 201	SE 200 6417.2	one-sided	7 x full extension, 7 x EG 64/17	€1,062.00
5	72 x 50 x 201	SE 200 6422.2	one-sided	6 x full extension, 6 x EG 64/22	€1,002.00
6	72 x 50 x 201	SE 200 643212.2	one-sided	7 x full extension, 2 x EG 64/32, 5 x EG 64/12	€1,065.00
7	72 x 50 x 201	SE 200 644232.2	one-sided	4 x full extension, 2 x EG 64/42, 2 x EG 64/32	€883.09

SYSTEM TROLLEYS FOR EURO CONTAINERS 80 x 60 cm HEIGHT 134 cm

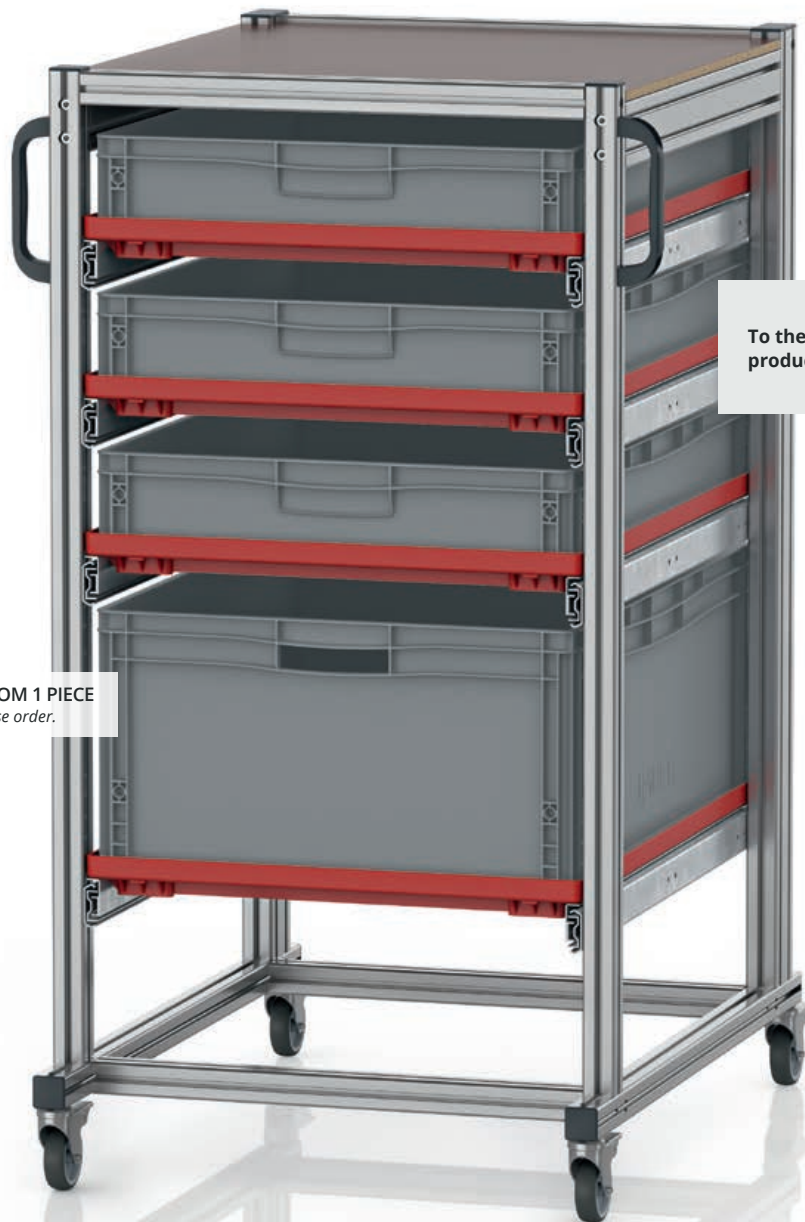

To the product video: 

AVAILABLE UP FROM 1 PIECE
no minimum purchase order.

5

Mobile organisation with huge capacity

The system trolley for Euro containers made by AUER Packaging is the ideal solution when the content of large-volume Euro containers is continuously required at different work stations. With the help of this system trolley, there is no need for laborious task of reloading the content onto pallets for transportation purposes or for carrying loads by hand.

- Stable aluminium profile
- High load-bearing capacity
- For containers with basic dimensions of 80 x 60 cm
- Lockable easy running rollers
- Easy to move, even when loaded



SYSTEM TROLLEYS FOR EURO CONTAINERS 80 x 60 cm HEIGHT 134 cm

	Outer dimensions L x W x H (cm)	Article No.	Design	Equipment	Price for single unit
1	70 x 94 x 134	SE 134 86 U	one-sided	5 x full extension	€1,055.00
2	70 x 94 x 134	SE 134 8612	one-sided	5 x full extension, 5 x EG 86/12 HG	€1,149.00
3	70 x 94 x 134	SE 134 8622	one-sided	3 x full extension, 3 x EG 86/22	€969.69
4	70 x 94 x 134	SE 134 8642	one-sided	2 x full extension, 2 x EG 86/42	€886.59
5	70 x 94 x 134	SE 134 863212	one-sided	4 x full extension, 1 x EG 86/32, 3 x EG 86/12 HG	€1,060.00

SYSTEM TROLLEYS FOR EURO CONTAINERS 80 x 60 cm HEIGHT 200 cm

AVAILABLE UP FROM 1 PIECE
no minimum purchase order.



To the
product video:



Mobile organisation - XXL in terms of height and capacity

The system trolley for Euro containers made by AUER Packaging is the ideal solution when the content of very many large-volume Euro containers is continuously required at different work stations. With the help of this system trolley, there is no need for laborious task of reloading the content onto pallets for transportation purposes or for carrying loads by hand.

- Stable aluminium profile
- High load-bearing capacity
- Maximum usable volume
- Lockable easy running rollers
- Easy to move, even when loaded



SYSTEM TROLLEYS FOR EURO CONTAINERS 80 x 60 cm HEIGHT 200 cm

	Outer dimensions L x W x H (cm)	Article No.	Design	Equipment	Price for single unit
1	70 x94 x200	SE 200 86 U	one-sided	6 x full extension	€1,167.00
2	70 x94 x200	SE 200 8612	one-sided	9 x full extension, 9 x EG 86/12 HG	€1,571.00
3	70 x94 x200	SE 200 8622	one-sided	6 x full extension, 6 x EG 86/22	€1,310.00
4	70 x94 x200	SE 200 863212	one-sided	7 x full extension, 5 x EG 86/12 HG, 2 x EG 86/32	€1,393.00
5	70 x94 x200	SE 200 864232	one-sided	4 x full extension, 2 x EG 86/42, 2 x EG 86/32	€1,131.00

SYSTEM TROLLEYS FOR EURO CONTAINERS 60 x 40 cm HEIGHT 134 cm WITHOUT DRAWERS

AVAILABLE UP FROM 1 PIECE
no minimum purchase order.



Systematic mobility

The Euro container system trolleys without drawers enable the containers to go anywhere in your entire operation. A tray equipped with an edge that runs around the container will secure the container in place. The contents of every container can be accessed on both sides of the system trolley.

- Stable aluminium profile
- High payload
- Fixed smooth-rolling casters



SYSTEM TROLLEY FOR EURO CONTAINERS 60 x 40 cm HEIGHT 134 cm, WITHOUT DRAWERS

	Outer dimensions L x W x H (cm)	Article No.	Design	Equipment	Unit price on pallet
1	83 x55 x135	EG SW 134-1 64 U	one-sided	4× tray	€726.03
2	83 x55 x135	EG SW 134-1 6475	one-sided	5× tray, 5× EG 64/75	€799.65
3	83 x55 x135	EG SW 134-1 6412	one-sided	5× tray, 5× EG 64/12	€805.27
4	83 x55 x135	EG SW 134-1 6417	one-sided	5× tray, 5× EG 64/17	€810.95
5	83 x55 x135	EG SW 134-1 6422	one-sided	4× tray, 4× EG 64/22	€765.80
6	83 x55 x135	EG SW 134-1 6427	one-sided	3× tray, 3× EG 64/27	€720.46
7	83 x55 x135	EG SW 134-1 6432	one-sided	3× tray, 3× EG 64/32	€724.37
8	83 x55 x135	EG SW 134-1 6442	one-sided	3× tray, 3× EG 64/42	€733.54

SYSTEM TROLLEYS FOR EURO CONTAINERS 60 x 40 cm HEIGHT 200 cm WITHOUT DRAWERS

AVAILABLE UP FROM 1 PIECE
no minimum purchase order.



Systematic mobility

The Euro container system trolleys without drawers enable the containers to go anywhere in your entire operation. A tray equipped with an edge that runs around the container will secure the container in place. The contents of every container can be accessed on both sides of the system trolley.

- Stable aluminium profile
- High payload
- Fixed smooth-rolling casters

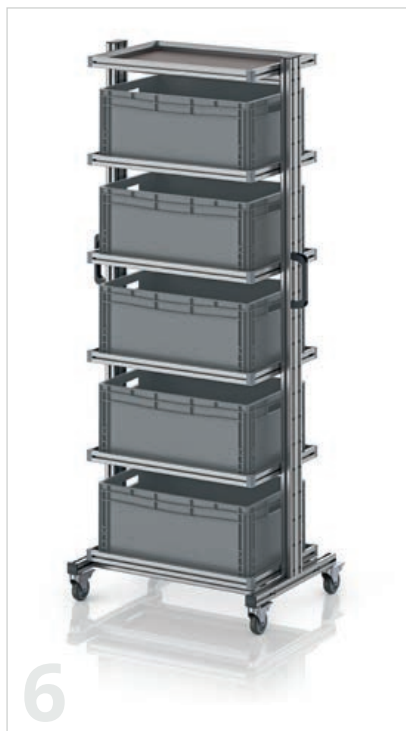
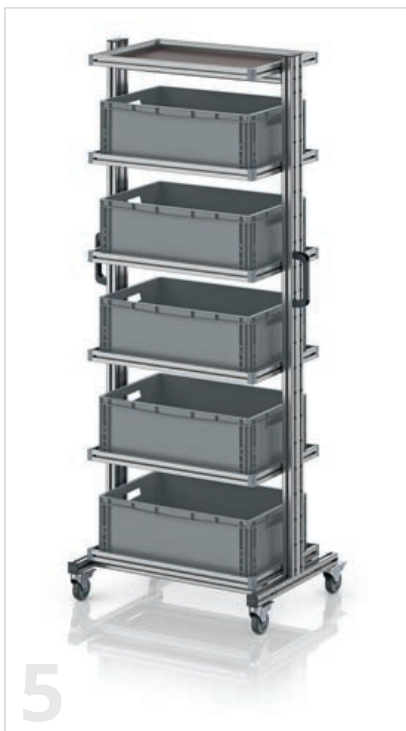

SYSTEM TROLLEY FOR EURO CONTAINERS 60 x 40 cm HEIGHT 200 cm, WITHOUT DRAWERS

	Outer dimensions L x W x H (cm)	Article No.	Design	Equipment	Unit price on pallet
1	83 x55 x201	EG SW 200-1 64 U	one-sided	5× tray	€880.34
2	83 x55 x201	EG SW 200-1 6475	one-sided	11× tray, 11× EG 64/75	€1,157.00
3	83 x55 x201	EG SW 200-1 6412	one-sided	7 x Tablar, 6 x EG 64/12	€1,009.00
4	83 x55 x201	EG SW 200-1 6417	one-sided	6× tray, 5× EG 64/17	€965.26
5	83 x55 x201	EG SW 200-1 6422	one-sided	6× tray, 5× EG 64/22	€970.98
6	83 x55 x201	EG SW 200-1 6427	one-sided	6 x Tablar, 5 x EG 64/27	€980.21
7	83 x55 x201	EG SW 200-1 6432	one-sided	5× tray, 4× EG 64/32	€932.70
8	83 x55 x201	EG SW 200-1 6442	one-sided	4× tray, 3× EG 64/42	€887.85

SYSTEM TROLLEYS FOR EURO CONTAINERS 80 x 60 cm HEIGHT 134 cm WITHOUT DRAWERS

AVAILABLE UP FROM 1 PIECE
no minimum purchase order.



Systematic mobility

The Euro container system trolleys without drawers enable the containers to go anywhere in your entire operation. A tray equipped with an edge that runs around the container will secure the container in place. The contents of every container can be accessed on both sides of the system trolley.

- Stable aluminium profile
- High payload
- Fixed smooth-rolling casters



SYSTEM TROLLEY FOR EURO CONTAINERS 80 x 60 cm HEIGHT 134 cm, WITHOUT DRAWERS

	Outer dimensions L x W x H (cm)	Article No.	Design	Equipment	Unit price on pallet
1	103 x65 x135	EG SW 134-1 86 U	one-sided	4× tray	€865.23
2	103 x65 x135	EG SW 134-1 8612	one-sided	5× tray, 5× EG 86/12 HG	€1,029.00
3	103 x65 x135	EG SW 134-1 8622	one-sided	4× tray, 4× EG 86/22	€960.56
4	103 x65 x135	EG SW 134-1 8632	one-sided	3× tray, 3× EG 86/32	€875.65
5	103 x65 x135	EG SW 134-1 8642	one-sided	3× tray, 3× EG 86/42	€895.39
6	103 x65 x135	EG SW 134-1 8652	one-sided	2 x Tablar, 2 x EG 86/52	€809.67

SYSTEM TROLLEYS FOR EURO CONTAINERS 80 x 60 cm HEIGHT 200 cm WITHOUT DRAWERS

AVAILABLE UP FROM 1 PIECE
no minimum purchase order.

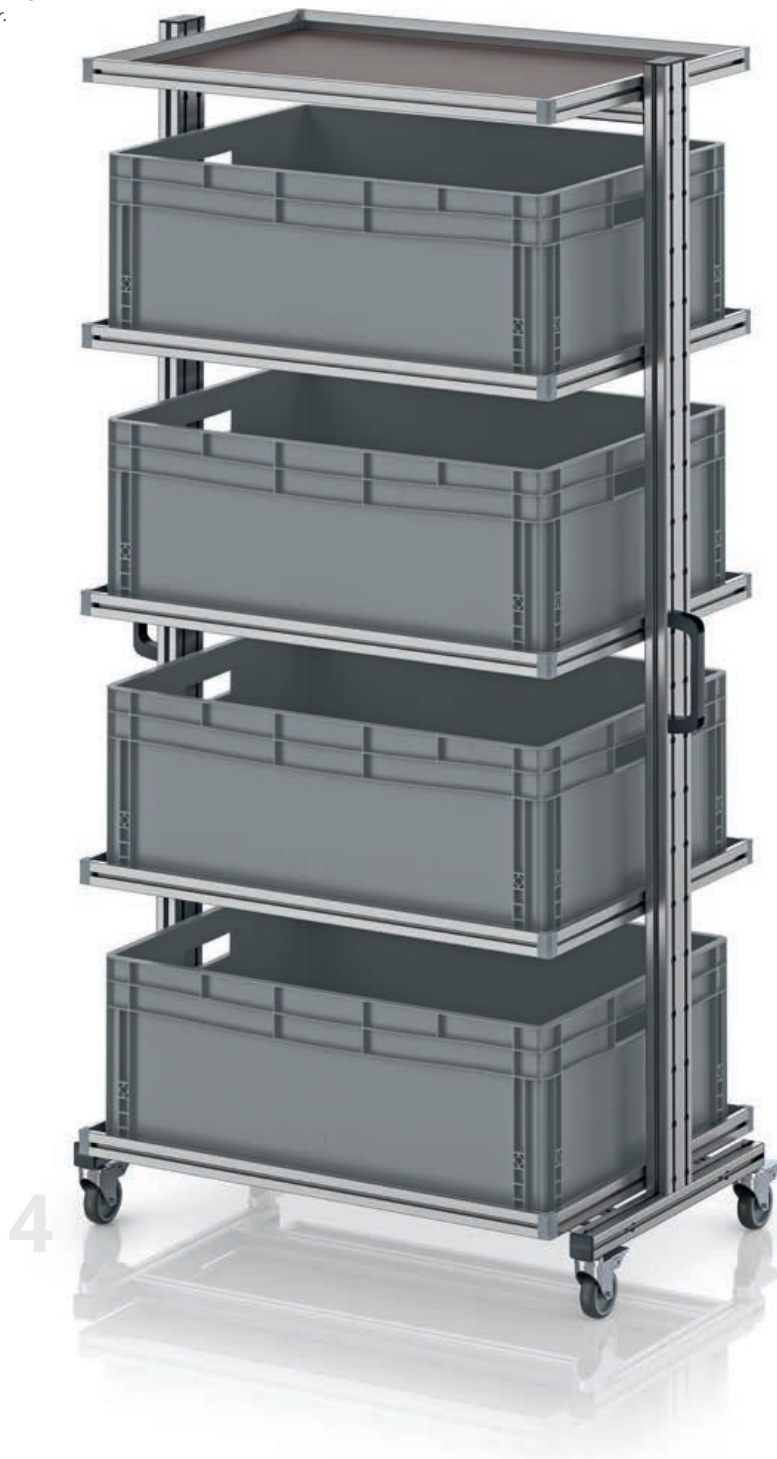

Systematic mobility

The Euro container system trolleys without drawers enable the containers to go anywhere in your entire operation. A tray equipped with an edge that runs around the container will secure the container in place. The contents of every container can be accessed on both sides of the system trolley.

- Stable aluminium profile
- High payload
- Fixed smooth-rolling casters



1



2

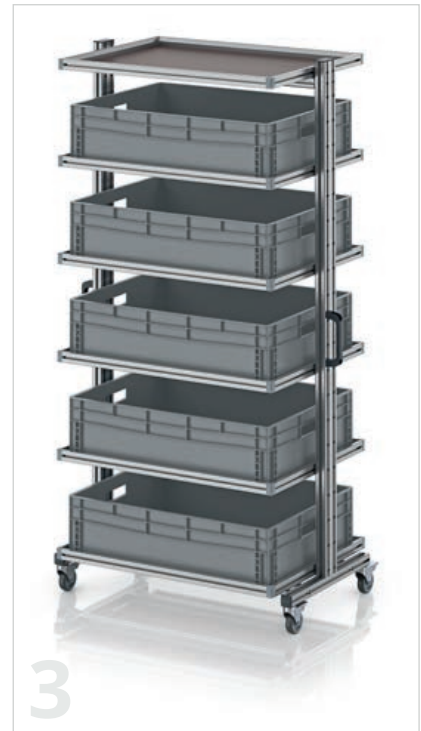

3



5



6

SYSTEM TROLLEY FOR EURO CONTAINERS 80 x 60 cm HEIGHT 200 cm, WITHOUT DRAWERS

	Outer dimensions L x W x H (cm)	Article No.	Design	Equipment	Unit price on pallet
1	103 x65 x201	EG SW 200-1 86 U	one-sided	5× tray	€1,049.00
2	103 x65 x201	EG SW 200-1 8612	one-sided	6× tray, 6× EG 86/12 HG	€1,231.00
3	103 x65 x201	EG SW 200-1 8622	one-sided	6× tray, 5× EG 86/22	€1,238.00
4	103 x65 x201	EG SW 200-1 8632	one-sided	5× tray, 4× EG 86/32	€1,155.00
5	103 x65 x201	EG SW 200-1 8642	one-sided	4× tray, 3× EG 86/42	€1,079.00
6	103 x65 x201	EG SW 200-1 8652	one-sided	3 x Tablar, 2 x EG 86/52	€992.68

SYSTEM TROLLEYS FOR EURO CONTAINERS 60 x 40 cm HEIGHT 134 cm INCLINABLE

AVAILABLE UP FROM 1 PIECE
no minimum purchase order.



Comfortable on every level

Nearly all levels of inclinable Euro container system trolleys can be leaned towards the user. This feature facilitates particularly easy access to the Euro containers and provides a maximum overview. A tray equipped with an edge that runs around the container will secure the container in place. Every level can be leaned towards both sides of the system trolley.

- Stable aluminium profile
- All levels can be continuously inclined, with the exception the lowest level
- High payload
- Fixed smooth-rolling casters



SYSTEM TROLLEY FOR EURO CONTAINERS 60 x 40 cm HEIGHT 134 cm, INCLINABLE

	Outer dimensions L x W x H (cm)	Article No.	Design	Equipment	Unit price on pallet
1	83 x55 x135	EG SWN 134 64 U	one-sided	3× inclinable tray, 1× rigid tray	€856.39
2	83 x55 x135	EG SWN 134 6475	one-sided	4× inclinable tray, 1× rigid tray, 5× EG 64/75 HG	€973.46
3	83 x55 x135	EG SWN 134 6412	one-sided	4× inclinable tray, 1× rigid tray, 5× EG 64/12	€979.09
4	83 x55 x135	EG SWN 134 6417	one-sided	3× inclinable tray, 1× rigid tray, 4× EG 64/17	€891.58
5	83 x55 x135	EG SWN 134 6422	one-sided	3× inclinable tray, 1× rigid tray, 4× EG 64/22	€896.16

SYSTEM TROLLEYS FOR EURO CONTAINERS 60 x 40 cm HEIGHT 200 cm INCLINABLE

AVAILABLE UP FROM 1 PIECE
no minimum purchase order.



Comfortable on every level

Nearly all levels of inclinable Euro container system trolleys can be leaned towards the user. This feature facilitates particularly easy access to the Euro containers and provides a maximum overview. A tray equipped with an edge that runs around the container will secure the container in place. Every level can be leaned towards both sides of the system trolley.

- Stable aluminium profile
- All levels can be continuously inclined, with the exception the lowest level
- High payload
- Fixed smooth-rolling casters



SYSTEM TROLLEY FOR EURO CONTAINERS 60 x 40 cm HEIGHT 200 cm, INCLINABLE

	Outer dimensions L x W x H (cm)	Article No.	Design	Equipment	Unit price on pallet
1	83 x55 x201	EG SWN 200 64 U	one-sided	5× inclinable tray, 1× rigid tray	€1,139.00
2	83 x55 x201	EG SWN 200 6475	one-sided	8× inclinable tray, 1× rigid tray, 9× EG 64/75 HG	€1,451.00
3	83 x55 x201	EG SWN 200 6412	one-sided	6× inclinable tray, 1× rigid tray, 7× EG 64/12	€1,277.00
4	83 x55 x201	EG SWN 200 6417	one-sided	5× inclinable tray, 1× rigid tray, 5× EG 64/12	€1,183.00
5	83 x55 x201	EG SWN 200 6422	one-sided	5× inclinable tray, 1× rigid tray, 5× EG 64/22	€1,189.00

SYSTEM TROLLEYS FOR EURO CONTAINERS 80 x 60 cm HEIGHT 134 cm INCLINABLE

AVAILABLE UP FROM 1 PIECE
no minimum purchase order.



Comfortable on every level

Nearly all levels of inclinable Euro container system trolleys can be leaned towards the user. This feature facilitates particularly easy access to the Euro containers and provides a maximum overview. A tray equipped with an edge that runs around the container will secure the container in place. Every level can be leaned towards both sides of the system trolley.

- Stable aluminium profile
- All levels can be continuously inclined, with the exception the lowest level
- High payload
- Fixed smooth-rolling casters



SYSTEM TROLLEY FOR EURO CONTAINERS 80 x 60 cm HEIGHT 134 cm, INCLINABLE

	Outer dimensions L x W x H (cm)	Article No.	Design	Equipment	Unit price on pallet
1	83 x55 x135	EG SWN 134 86 U	one-sided	3× inclinable tray, 1× rigid tray	€995.58
2	83 x55 x135	EG SWN 134 8612	one-sided	4× inclinable tray, 1× rigid tray, 5× EG 86/12 HG	€1,203.00
3	83 x55 x135	EG SWN 134 8622	one-sided	3× inclinable tray, 1× rigid tray, 4× EG 86/22	€1,091.00

SYSTEM TROLLEYS FOR EURO CONTAINERS 80 x 60 cm HEIGHT 200 cm INCLINABLE

AVAILABLE UP FROM 1 PIECE
no minimum purchase order.

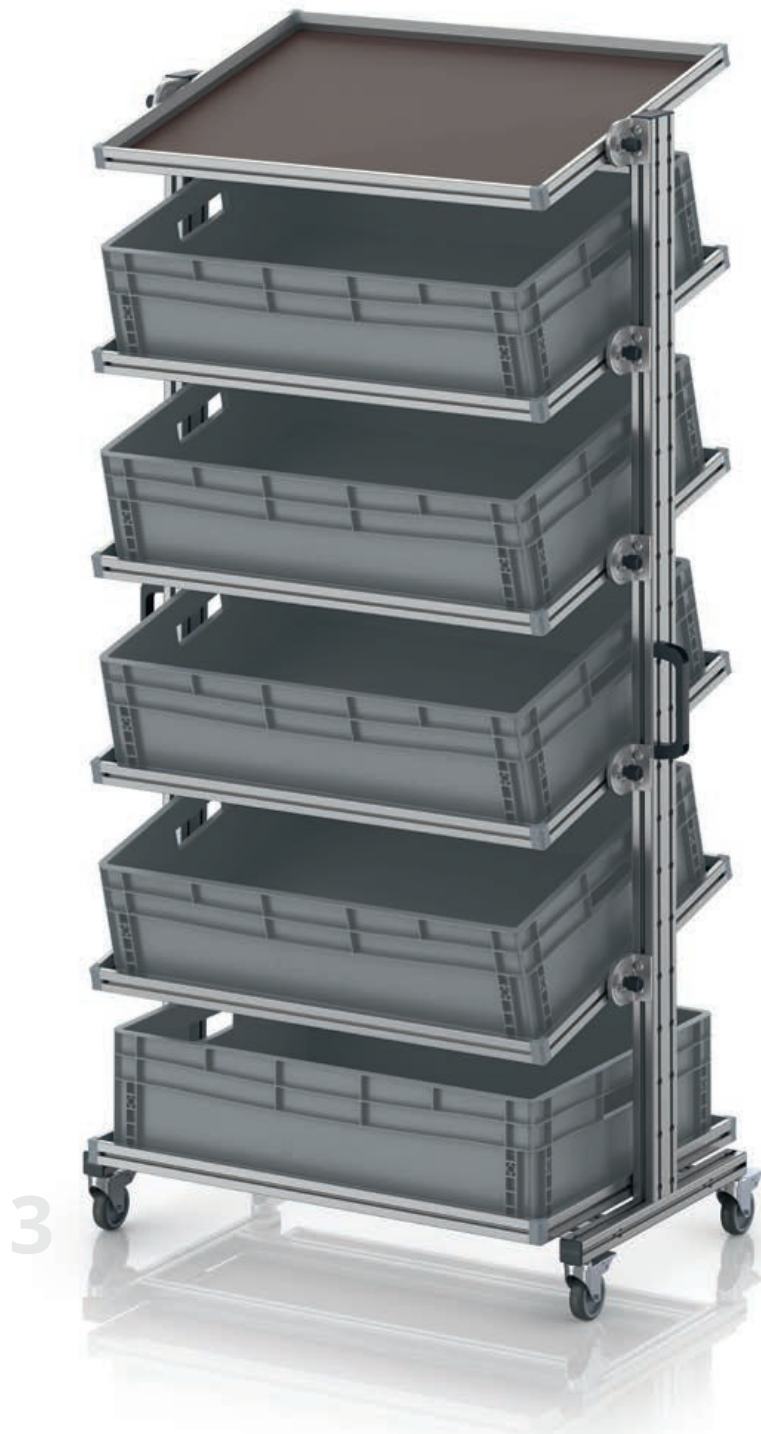

Comfortable on every level

Nearly all levels of inclinable Euro container system trolleys can be leaned towards the user. This feature facilitates particularly easy access to the Euro containers and provides a maximum overview. A tray equipped with an edge that runs around the container will secure the container in place. Every level can be leaned towards both sides of the system trolley.

- Stable aluminium profile
- All levels can be continuously inclined, with the exception the lowest level
- High payload
- Fixed smooth-rolling casters



SYSTEM TROLLEY FOR EURO CONTAINERS 80 x 60 cm HEIGHT 200 cm, INCLINABLE

	Outer dimensions L x W x H (cm)	Article No.	Design	Equipment	Unit price on pallet
1	103 x65 x201	EG SWN 200 86 U	one-sided	5× inclinable tray, 1× rigid tray	€1,336.00
2	103 x65 x201	EG SWN 200 8612	one-sided	6× inclinable tray, 1× rigid tray, 7× EG 86/12 HG	€1,580.00
3	103 x65 x201	EG SWN 200 8622	one-sided	5× inclinable tray, 1× rigid tray, 5× EG 86/22	€1,455.00

SYSTEM TROLLEY IN PALLET FORMAT

AVAILABLE UP FROM 1 PIECE
no minimum purchase order.



Large-format trolley

When you want to store as much as possible on each level, our pallet-format system trolleys are unbeatable. The large trays in Euro and industrial-pallet formats come with a retaining edge that encircles the rim. The system trolleys equipped with smooth-rolling casters can bring all of the things you need to work effectively to the very place where they are needed.

- Maximum usage space on every level
- Stable aluminium profile
- High payload
- Fixed smooth-rolling casters



SYSTEM TROLLEY IN PALLET FORMAT

	Outer dimensions L x W x H (cm)	Article No.	Equipment	Unit price on pallet
1	130 x 106 x 135	EG SW 134 1208 U	4× tray	€1,465.00
2	130 x 106 x 135	EG SW 134 1208-6412	6× tray, 24× EG 64/12	€2,216.00
3	130 x 106 x 135	EG SW 134 1208-6417	5× tray, 20× EG 64/17	€2,022.00
4	130 x 106 x 135	EG SW 134 1208-6422	4× tray, 16× EG 64/22	€1,819.00
5	130 x 126 x 135	EG SW 134 1210 U	4× tray	€1,485.00
6	130 x 126 x 135	EG SW 134 1210-6412	6× tray, 30× EG 64/12	€2,282.00
7	130 x 126 x 135	EG SW 134 1210-6417	5× tray, 25× EG 64/17	€2,086.00
8	130 x 126 x 135	EG SW 134 1210-6422	4× tray, 20× EG 64/22	€1,879.00

ESD PRODUCTS

Safe from electrostatic charges





ESD EURO CONTAINERS

AVAILABLE UP FROM 1 PIECE
no minimum purchase order.



READY FOR DISPATCH within **24** hours **



Customised anti-static properties

AUER Packaging's ESD Euro container is made from electrically conductive plastic and is consequently especially suitable for the safe storage and transportation of electronic goods.

- Electrically conductive material
- All commonly used Euro formats
- Also stackable with lid
- Especially sturdy

ESD EURO CONTAINERS

RAL 9017

Outer dimensions L x W x H (cm)	Article No.	Price for single unit	Units on pallet	Unit price on pallet
20 x 15 x 12.0	ESD EG 21512 HG	€2.69	760	€2.07
30 x 20 x 12.0	ESD EG 32/12 HG	€4.09	380	€3.14
30 x 20 x 17.0	ESD EG 32/17 HG	€4.67	260	€3.59
40 x 30 x 7.5	ESD EG 43/75 HG	€5.18	330	€3.99
40 x 30 x 12.0	ESD EG 43/12 HG	€6.30	190	€4.85
40 x 30 x 17.0	ESD EG 43/17 HG	€7.47	130	€5.74
40 x 30 x 22.0	ESD EG 43/22 HG	€8.61	140	€6.62
40 x 30 x 27.0	ESD EG 43/27 HG	€9.00	80	€6.92
40 x 30 x 32.0	ESD EG 43/32 HG	€10.03	70	€7.72
60 x 40 x 7.5	ESD EG 64/75 HG	€8.06	165	€6.20
60 x 40 x 12.0	ESD EG 64/12 HG	€9.68	95	€7.45
60 x 40 x 17.0	ESD EG 64/17 HG	€11.39	65	€8.76
60 x 40 x 22.0	ESD EG 64/22 HG	€12.50	50	€9.61
60 x 40 x 27.0	ESD EG 64/27 HG	€14.52	40	€11.17
60 x 40 x 32.0	ESD EG 64/32 HG	€15.37	45	€11.83
60 x 40 x 42.0	ESD EG 64/42 HG	€18.51	25	€14.24
80 x 60 x 12.0	ESD EG 86/12 HG	€23.89	34	€18.38
80 x 60 x 22.0	ESD EG 86/22 HG	€28.72	20	€22.09
80 x 60 x 32.0	ESD EG 86/32 HG	€32.98	12	€25.37
80 x 60 x 42.0	ESD EG 86/42 HG	€39.65	14	€30.50
80 x 60 x 52.0	ESD EG 86/52 HG	€47.62	12	€36.63



***) only for orders placed via the online shop. Dispatch only on working days, provided the goods are in stock.
Information regarding availability and current dispatch times can be found in the online shop.

ESD EURO CONTAINERS WITH HINGE LID



READY FOR DISPATCH within **24** hours **

AVAILABLE UP FROM 1 PIECE
no minimum purchase order.



All-round protection

AUER Packaging's ESD Euro container with hinge lid provides additional protection for its contents. The lid and the hinges are manufactured from the same anti-static material as the containers. This prevents electrostatic charges from building up and existing charges are reliably discharged.

- Electrically conductive material
- All commonly used Euro formats
- Stackable
- Sturdy hinges

ESD EURO CONTAINERS WITH HINGE LID

RAL 9017

Outer dimensions L x W x H (cm)	Article No.	Price for single unit	Units on pallet	Unit price on pallet
20 x 15 x 13.5	ESD ED 21512 HG	€7.22	640	€5.56
30 x 20 x 13.5	ESD ED 32/12 HG	€7.20	320	€5.54
30 x 20 x 18.5	ESD ED 32/17 HG	€7.95	240	€6.12
40 x 30 x 9.0	ESD ED 43/75 HG	€16.01	270	€12.31
40 x 30 x 13.5	ESD ED 43/12 HG	€17.21	160	€13.24
40 x 30 x 18.5	ESD ED 43/17 HG	€17.86	120	€13.74
40 x 30 x 23.5	ESD ED 43/22 HG	€18.38	90	€14.14
40 x 30 x 28.5	ESD ED 43/27 HG	€19.03	70	€14.64
40 x 30 x 33.5	ESD ED 43/32 HG	€19.85	60	€15.27
60 x 40 x 9.0	ESD ED 64/75 HG	€24.11	130	€18.55
60 x 40 x 13.5	ESD ED 64/12 HG	€24.46	85	€18.82
60 x 40 x 18.5	ESD ED 64/17 HG	€24.97	60	€19.21
60 x 40 x 23.5	ESD ED 64/22 HG	€25.55	45	€19.66
60 x 40 x 28.5	ESD ED 64/27 HG	€25.60	35	€19.70
60 x 40 x 33.5	ESD ED 64/32 HG	€25.67	30	€19.75
60 x 40 x 43.5	ESD ED 64/42 HG	€28.25	25	€21.73
80 x 60 x 14.0	ESD ED 86/12 HG	€70.14	34	€53.95
80 x 60 x 23.5	ESD ED 86/22 HG	€73.77	18	€56.75
80 x 60 x 33.5	ESD ED 86/32 HG	€76.67	12	€58.98
80 x 60 x 43.5	ESD ED 86/42 HG	€80.11	10	€61.63
80 x 60 x 54.0	ESD ED 86/52 HG	€68.73	8	€52.87



***) only for orders placed via the online shop. Dispatch only on working days, provided the goods are in stock.
Information regarding availability and current dispatch times can be found in the online shop.

ESD STORAGE BOXES WITH OPEN FRONT SK

READY FOR DISPATCH **24** hours ^{**} within

AVAILABLE UP FROM 1 PIECE
no minimum purchase order.

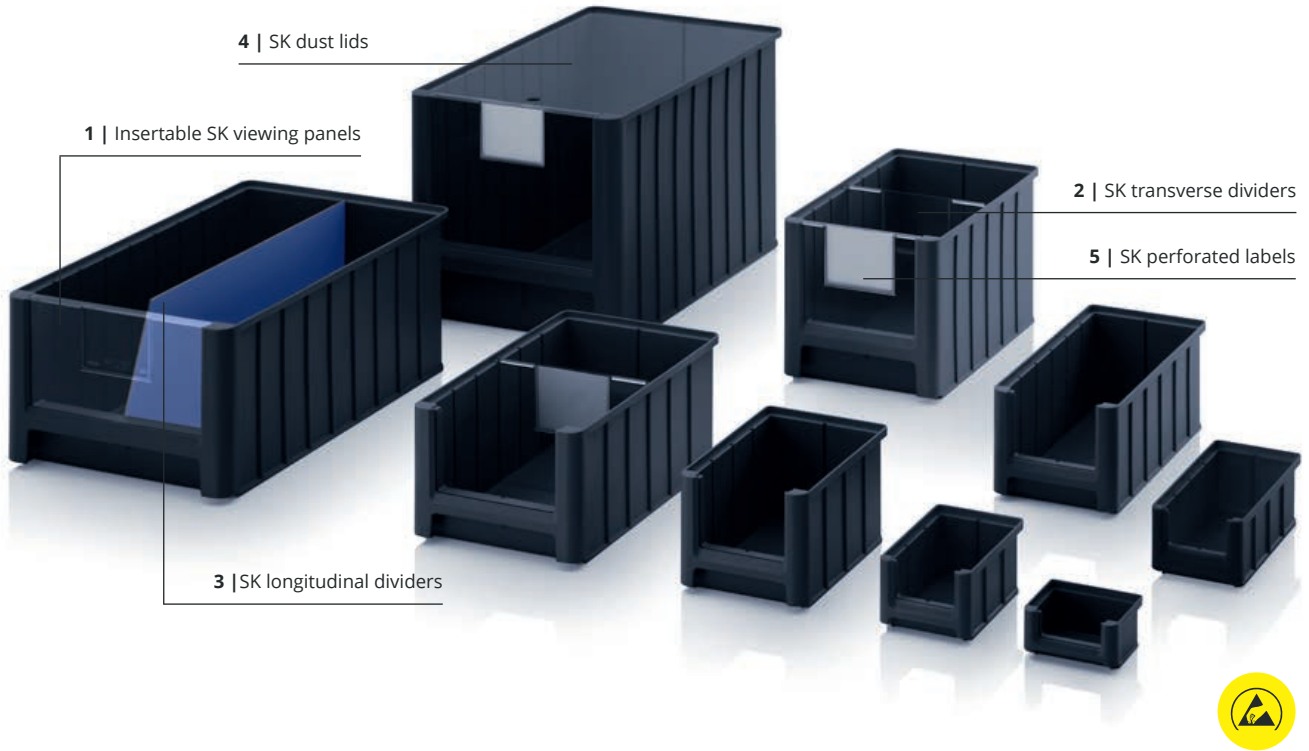

Anti-static functionality

The outstanding feature of AUER Packaging's SK ESD storage box with open front is maximum flexibility and functionality. It can be subdivided using various inserts, and it can be provided with viewing panels as well as a dust lid. As an electrically conductive storage box with open front, the container is optimised for the storage of electronic components.

- Electrically conductive material
- Very stable design
- Plenty of space for contents
- Stackable

ESD STORAGE BOXES WITH OPEN FRONT SK

RAL 9017

Outer dimensions L x W x H (cm)	Article No.	Viewing/access opening W x H (cm)	Price for single unit	Units on pallet	Unit price on pallet
8.5 x 10.2 x 5.0	ESD SK 1	6.8 x 2.7	€2.30	6150	€1.77
16.0 x 10.2 x 7.5	ESD SK 2	6.8 x 4.1	€2.73	2000	€2.10
22.0 x 10.2 x 7.5	ESD SK 2L	6.8 x 4.1	€2.91	1240	€2.24
22.5 x 15.0 x 12.5	ESD SK 3	10.2 x 7.6	€3.67	576	€2.82
32.5 x 15.0 x 12.5	ESD SK 3L	10.2 x 7.6	€4.21	378	€3.24
35.0 x 21.0 x 15.0	ESD SK 4	15.2 x 9.2	€5.37	210	€4.13
35.0 x 21.0 x 20.0	ESD SK 4H	15.2 x 12.6	€6.12	154	€4.71
50.0 x 31.0 x 20.0	ESD SK 5	24.0 x 12.6	€8.79	77	€6.76
50.0 x 31.0 x 30.0	ESD SK 5H	24.0 x 19.5	€11.02	49	€8.47



***) only for orders placed via the online shop. Dispatch only on working days, provided the goods are in stock. Information regarding availability and current dispatch times can be found in the online shop.

1 | INSERTABLE SK VIEWING PANELS

transparent

Article No.	Suitable for	Price for single unit	Units on pallet	Unit price on pallet
ES 1	SK 1	€0.31	73600	€0.24
ES 2	SK 2, SK 2L	€0.33	37760	€0.26
ES 3	SK 3, SK 3L	€0.39	14400	€0.30
ES 4	SK 4	€0.69	7680	€0.53
ES 4H	SK 4H	€0.70	8400	€0.54
ES 5	SK 5	€1.40	3840	€1.08
ES 5H	SK 5H	€1.56	3360	€1.20



- Provides protection from damage and dirt
- With label field
- Made of transparent plastic

2 | SK TRANSVERSE DIVIDERS

transparent

Article No.	Suitable for	Price for single unit	Units on pallet	Unit price on pallet
QT 2	SK 2, SK 2L	€0.35	23040	€0.27
QT 3	SK 3, SK 3L	€0.45	7680	€0.35
QT 4	SK 4	€0.70	6000	€0.54
QT 4H	SK 4H	€0.88	5040	€0.68
QT 5	SK 5	€1.54	3600	€1.19
QT 5H	SK 5H	€2.21	1920	€1.70



- With label field
- Made of transparent plastic
- Adjustable in 50 mm increments
- Provides firm grip

3 | SK LONGITUDINAL DIVIDERS

RAL 5015

Article No.	Suitable for	Price for single unit	Units on pallet	Unit price on pallet
LT 2	SK 2	€2.16	1000	€1.67
LT 2L	SK 2L	€2.44	1000	€1.88
LT 3	SK 3	€3.14	1000	€2.42
LT 3L	SK 3L	€3.92	1000	€3.02
LT 4	SK 4	€5.48	1000	€4.22
LT 4H	SK 4H	€7.22	1000	€5.55
LT 5	SK 5	€9.11	1000	€7.01
LT 5H	SK 5H	€12.71	1000	€9.78

- For dividing lengthwise
- Better overview
- Made of blue-coated special plastic

4 | SK DUST LIDS

transparent

Article No.	Suitable for	Price for single unit	Units on pallet	Unit price on pallet
SD 1	SK 1	€1.78	1000	€1.37
SD 2	SK 2	€2.07	1000	€1.59
SD 2L	SK 2L	€2.56	1000	€1.97
SD 3	SK 3	€3.14	1000	€2.42
SD 3L	SK 3L	€3.34	1000	€2.57
SD 4	SK 4, SK 4H	€3.63	1000	€2.79
SD 5	SK 5, SK 5H	€4.56	1000	€3.51



- Provides protection from damage and dirt
- With grab hole for easier removal
- Made of clear Plexiglas

5 | SK PERFORATED LABELS

RAL 9016

Article No.	Suitable for	Number of labels per pack	1 - 9 per unit	starting at 10 per unit
PE SK 1	SK 1	900	€27.34	€21.03
PE SK 2	SK 2, SK 2L	450	€27.34	€21.03
PE SK 3	SK 3, SK 3L	150	€27.34	€21.03
PE SK 4	SK 4, SK 4H	150	€27.34	€21.03
PE SK 5	SK 5, SK 5H	150	€27.34	€21.03

- Perforated labels
- 140 g/sqm
- Suitable for inkjet and laser printing

ESD RACK BOXES AND MATERIAL FLOW BOXES

AVAILABLE UP FROM 1 PIECE
no minimum purchase order.

READY FOR DISPATCH **24** hours**
within

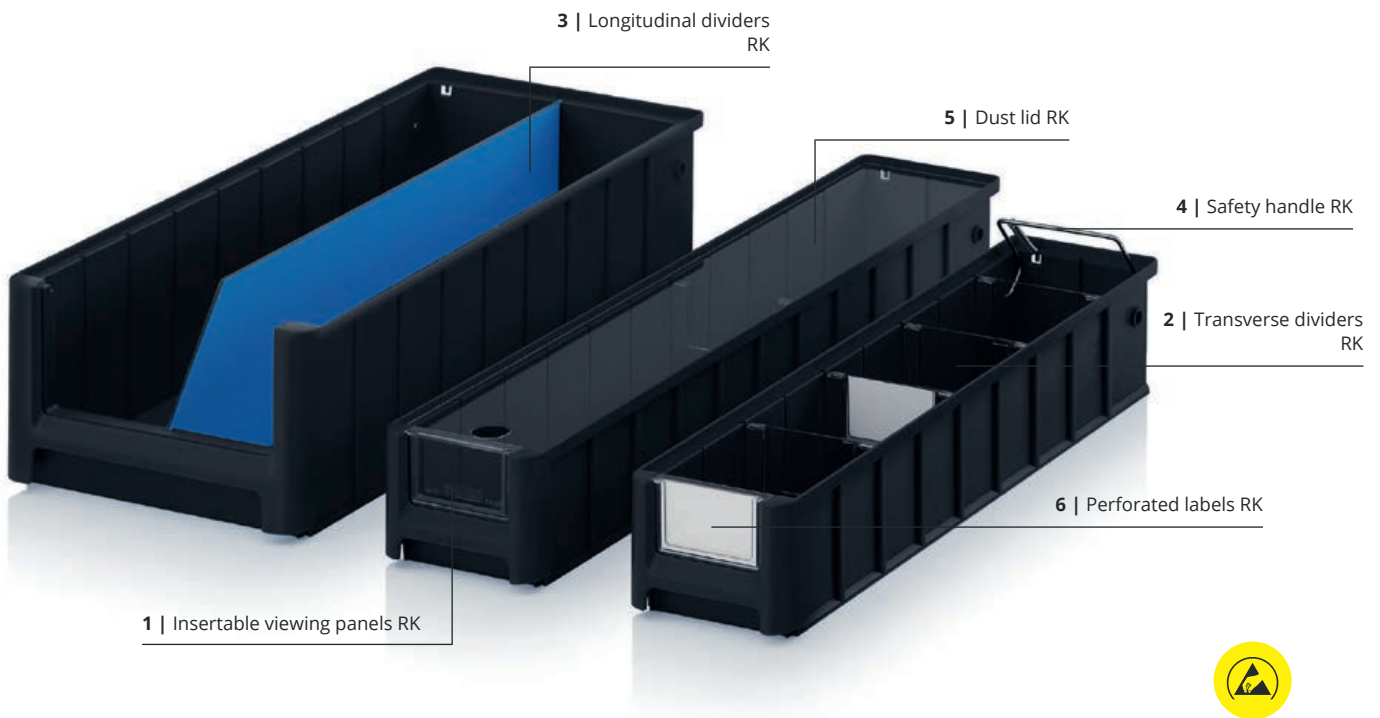

Anti-static small parts storage system

The AUER Packaging ESD shelf and material flow container fits perfectly into the AUER system trolley and can be ordered for shelf depths from 30cm to 60cm. Windows, longitudinal and cross dividers, dust covers and labels are also provided for a clear overview. As an electrically conductive box, it is ideally suited for storing electronic components.

- Electrically conductive material
- Very stable design
- Wide range of accessories
- Stackable

ESD RACK BOXES AND MATERIAL FLOW BOXES

RAL 9017

Outer dimensions L x W x H (cm)	Article No.	For shelf depth (cm)	Viewing/access opening W x H (cm)	Price for single unit	Units per pallet	Unit price on pallet
30 x 11.7 x 9	ESD RK 3109	30	7.6 x 4.7	€2.40	832	€1.85
30 x 15.6 x 9	ESD RK 31509	30	10.7 x 4.7	€2.56	624	€1.97
30 x 23.4 x 9	ESD RK 3209	30	17.6 x 4.7	€3.31	416	€2.55
30 x 23.4 x 14	ESD RK 3214	30	17.6 x 8.7	€3.95	256	€3.04
40 x 11.7 x 9	ESD RK 4109	40	7.6 x 4.7	€2.81	624	€2.16
40 x 15.6 x 9	ESD RK 41509	40	10.7 x 4.7	€3.14	468	€2.41
40 x 23.4 x 9	ESD RK 4209	40	17.6 x 4.7	€3.65	312	€2.80
40 x 23.4 x 14	ESD RK 4214	40	17.6 x 8.7	€4.57	192	€3.52
50 x 11.7 x 9	ESD RK 5109	50	7.6 x 4.7	€3.27	520	€2.52
50 x 15.6 x 9	ESD RK 51509	50	10.7 x 4.7	€3.66	364	€2.82
50 x 23.4 x 9	ESD RK 5209	50	17.6 x 4.7	€4.41	260	€3.39
50 x 23.4 x 14	ESD RK 5214	50	17.6 x 8.7	€5.77	160	€4.44
60 x 11.7 x 9	ESD RK 6109	60	7.6 x 4.7	€3.95	416	€3.04
60 x 15.6 x 9	ESD RK 61509	60	10.7 x 4.7	€4.40	312	€3.38
60 x 23.4 x 9	ESD RK 6209	60	17.6 x 4.7	€5.27	208	€4.05
60 x 23.4 x 14	ESD RK 6214	60	17.6 x 8.7	€6.52	128	€5.02



***) only for orders placed via the online shop. Dispatch only on working days, provided the goods are in stock. Information regarding availability and current dispatch times can be found in the online shop.

ACCESSORIES RACK BOXES AND MATERIAL FLOW BOXES

1 | INSERTABLE VIEWING PANELS RK

transparent

Article No.	Suitable for	Price for single unit	Units on pallet	Unit price on pallet
ES 109	RK 3109, RK 4109, RK 5109, RK 6109	€0.46	34560	€0.35
ES 1509	RK 31509, RK 41509, RK 51509, RK 61509	€0.34	19200	€0.26
ES 209	RK 3209, RK 4209, RK 5209, RK 6209	€0.51	14400	€0.39
ES 214	RK 3214, RK 4214, RK 5214, RK 6214	€0.64	7200	€0.50

- Provides protection from damage and dirt
- With label field
- Made of transparent plastic

2 | TRANSVERSE DIVIDERS RK

transparent

Article No.	Suitable for	Price for single unit	Units on pallet	Unit price on pallet
QT 109	RK 3109, RK 4109, RK 5109, RK 6109	€0.50	21600	€0.38
QT 1509	RK 31509, RK 41509, RK 51509, RK 61509	€0.59	15360	€0.46
QT 209	RK 3209, RK 4209, RK 5209, RK 6209	€0.64	8640	€0.50
QT 214	RK 3214, RK 4214, RK 5214, RK 6214	€0.86	6480	€0.66

- With label field
- Made of transparent plastic
- Adjustable in 50 mm increments
- Provides firm grip

3 | LONGITUDINAL DIVIDERS RK

RAL 5015

Article No.	Suitable for	Price for single unit	Units on pallet	Unit price on pallet
LT 309	RK 3109, RK 31509, RK 3209	€3.30	1000	€2.54
LT 314	RK 3214	€4.27	1000	€3.29
LT 409	RK 4109, RK 41509, RK 4209	€4.43	1000	€3.41
LT 414	RK 4214	€5.75	1000	€4.43
LT 509	RK 5109, RK 51509, RK 5209	€5.58	1000	€4.29
LT 514	RK 5214	€7.25	1000	€5.58
LT 609	RK 6109, RK 61509, RK 6209	€6.71	1000	€5.16
LT 614	RK 6214	€8.74	1000	€6.72

- For dividing lengthwise
- Better overview
- Made of blue-coated special plastic

4 | SAFETY HANDLE RK

Article No.	Suitable for	Price for single unit	Units on pallet	Unit price on pallet
SB 117	RK 3109, RK 4109, RK 5109, RK 6109	€1.68	500	€1.29
SB 156	RK 31509, RK 41509, RK 51509, RK 61509	€1.69	500	€1.30
SB 234	RK 3209, RK 4209, RK 5209, RK 6209, RK 3214, RK 4214, RK 5214, RK 6214	€1.72	500	€1.32

- Holds box when tilted
- Acts as a carrying handle
- Galvanised steel
- Handle lowers automatically during stacking and insertion into rack

5 | DUST LID RK

transparent

Article No.	Suitable for	Price for single unit	Units on pallet	Unit price on pallet
SD 3117	RK 3109	€2.07	500	€1.59
SD 3156	RK 31509	€2.41	500	€1.85
SD 3234	RK 3209, RK 3214	€2.99	500	€2.30
SD 4117	RK 4109	€2.41	500	€1.85
SD 4156	RK 41509	€2.76	500	€2.12
SD 4234	RK 4209, RK 4214	€3.67	500	€2.83
SD 5117	RK 5109	€2.64	500	€2.03
SD 5156	RK 51509	€3.22	500	€2.47
SD 5234	RK 5209, RK 5214	€4.25	500	€3.27
SD 6117	RK 6109	€2.99	500	€2.30
SD 6156	RK 61509	€3.67	500	€2.83
SD 6234	RK 6209, RK 6214	€4.94	500	€3.80

- Provides protection from damage and dirt
- With grab hole for easier removal
- Made of clear Plexiglas

6 | PERFORATED LABELS RK

RAL 9016

Article No.	Suitable for	Number of labels per pack	1 – 9 per unit	starting at 10 per unit
QT PE 109	QT 109	300	€27.39	€21.07
ES PE 109	ES 109	300	€27.37	€21.06
QT PE 1509	QT 1509	300	€27.39	€21.07
ES PE 1509	ES 1509	300	€27.37	€21.06
QT PE 209	QT 209	150	€27.39	€21.07
ES PE 209	ES 209	150	€27.37	€21.06
QT PE 214	QT 214	75	€27.39	€21.07
ES PE 214	ES 214	75	€27.37	€21.06

- Perforated labels
- 140 g/sqm
- Suitable for inkjet and laser printing

ESD DRAWER CONTAINERS COMPLETE SYSTEM

AVAILABLE UP FROM 1 PIECE
no minimum purchase order.



1 | ESD SB-S2+

2 | ESD SB-S1



Always to hand

Thanks to its sturdy modular design, AUER Packaging's ESD drawer container can accommodate a large number of parts. The special, electrically conductive material provides reliable protection from electrical charges. The complete system consists of a transport trolley and drawer container, two drawer holders and six drawers.

- Electrically conductive material
- Available as single components
- 12 insertion grooves for drawers
- 2-12 drawers per container

ESD DRAWER CONTAINERS COMPLETE SYSTEM

RAL 9017

Article No.	Equipment	Price for single unit	Units on pallet	Unit price on pallet
1	ESD SB.S2+ 2 x ESD SB.42 equipped with: 2 x ESD SB.H, 2 x ESD W24-t, 2 x ESD W84-t, 2 x ESD W172-t, 1 x ESD SB.RO	€268.35	15	€206.42
2	ESD SB-S1 1 x ESD SB.42 equipped with: 1 x ESD SB.H, 1 x ESD W24-t, 1 x ESD W84-t, 1 x ESD W172-t	€119.66	25	€92.05



ESD DRAWER CONTAINERS SINGLE COMPONENTS



ESD DRAWER CONTAINERS

RAL 9017

	Outer dimensions L x W x H (cm)	Article No.	Description	Price for single unit	Units on pallet	Unit price on pallet
3	60.0 x 40.0 x 43.5	ESD SB.42	Drawer container including a hinged lid with an open long side	€33.29	25	€25.61



DRAWER HOLDER

RAL 9017

	Outer dimensions L x W x H (cm)	Article No.	Description	Price for single unit	Units on pallet	Unit price on pallet
4	40.8 x 36.7 x 3.4	ESD SB.H	Drawer holder with a maximum of 12 insertion grooves	€20.36	100	€15.66



ESD TRANSPORT TROLLEYS

RAL 9017

	Outer dimensions L x W (cm)	Article No.	Design Castors	Price for single unit	Units on pallet	Unit price on pallet
	62 x 42	ESD RO 64.4	4 steering castors	€38.31	84	€29.47
5	62 x 42	ESD RO 64.4 FE	2 steering castors, 2 steering castors with wheel stop	€42.45	84	€32.65
	82 x 62	ESD RO 86.4 HD	4 steering castors	€84.96	26	€65.36



ESD DRAWERS

RAL 9017

	Outer dimensions L x W x H (cm)	Article No.	Description	Price for single unit	Units on pallet	Unit price on pallet
6	52.0 x 35.7 x 2.4	ESD W24-t	Drawer, up to 12 drawers per box	€17.81	510	€13.70
7	52.0 x 35.7 x 8.4	ESD W84-t	Drawer, up to 4 drawers per box	€20.46	288	€15.74
8	52.0 x 35.7 x 17.2	ESD W172-t	Drawer, up to 2 drawers per box	€31.10	135	€23.92



ESD SYSTEM TROLLEYS FOR RACK BOXES



AVAILABLE UP FROM 1 PIECE
no minimum purchase order.



For optimum work processes

The appeal of the ESD system trolley for rack boxes from AUER packaging lies in its simple handling. Rack boxes and material flow boxes can simply be hooked into the perfectly matched aluminium rail system. This ensures that you have everything you need for your work clearly arranged and on hand exactly where you need it.

- Stable aluminium profile
- High load-bearing capacity
- Lockable easy running rollers



ESD SYSTEM TROLLEYS FOR RACK BOXES UNLOADED

RAL 9017

	Dimensions W x D x H (cm)	Article No.	Equipment	Design	Unit price
1	112 x 65 x 135	ESD SR.L	Unloaded (suitable for rack boxes 9 cm high)	one-sided	€515.55
2	112 x 65 x 135	ESD SR.L.214	Unloaded (suitable for rack boxes 14 cm high)	one-sided	€515.55



ESD SYSTEM TROLLEYS FOR RACK BOXES SHELF DEPTH 30 cm

RAL 9017

	Dimensions W x D x H (cm)	Article No.	Equipment	Design	Unit price
3	112 x 65 x 135	ESD SR.L.3109	56 x ESD RK 3109 (30 x 11,7 x 9 cm)	one-sided	€618.92
4	112 x 65 x 135	ESD SR.L.31509	42 x ESD RK 31509 (30 x 15,6 x 9 cm)	one-sided	€595.67
5	112 x 65 x 135	ESD SR.L.3209	28 x ESD RK 3209 (30 x 23,4 x 9 cm)	one-sided	€590.49
6	112 x 65 x 135	ESD SR.L.3214	20 x ESD RK 3214 (30 x 23,4 x 14 cm)	one-sided	€573.66



ESD SYSTEM TROLLEYS FOR RACK BOXES SHELF DEPTH 40 cm

RAL 9017

	Dimensions W x D x H (cm)	Article No.	Equipment	Design	Unit price
3	112 x 65 x 135	ESD SR.L.4109	56 x ESD RK 4109 (40 x 11,7 x 9 cm)	one-sided	€630.18
4	112 x 65 x 135	ESD SR.L.41509	42 x ESD RK 41509 (40 x 15,6 x 9 cm)	one-sided	€607.38
5	112 x 65 x 135	ESD SR.L.4209	28 x ESD RK 4209 (40 x 23,4 x 9 cm)	one-sided	€589.08
6	112 x 65 x 135	ESD SR.L.4214	20 x ESD RK 4214 (40 x 23,4 x 14 cm)	one-sided	€580.03



ESD SYSTEM TROLLEYS FOR RACK BOXES SHELF DEPTH 50 cm

RAL 9017

	Dimensions W x D x H (cm)	Article No.	Equipment	Design	Unit price
3	112 x 65 x 135	ESD SR.L.5109	56 x ESD RK 5109 (50 x 11,7 x 9 cm)	one-sided	€652.50
4	112 x 65 x 135	ESD SR.L.51509	42 x ESD RK 51509 (50 x 15,6 x 9 cm)	one-sided	€626.54
5	112 x 65 x 135	ESD SR.L.5209	28 x ESD RK 5209 (50 x 23,4 x 9 cm)	one-sided	€602.10
6	112 x 65 x 135	ESD SR.L.5214	20 x ESD RK 5214 (50 x 23,4 x 14 cm)	one-sided	€590.85



ESD SYSTEM TROLLEYS FOR EURO CONTAINERS 60 x 40 cm HEIGHT 134 cm

AVAILABLE UP FROM 1 PIECE
no minimum purchase order.

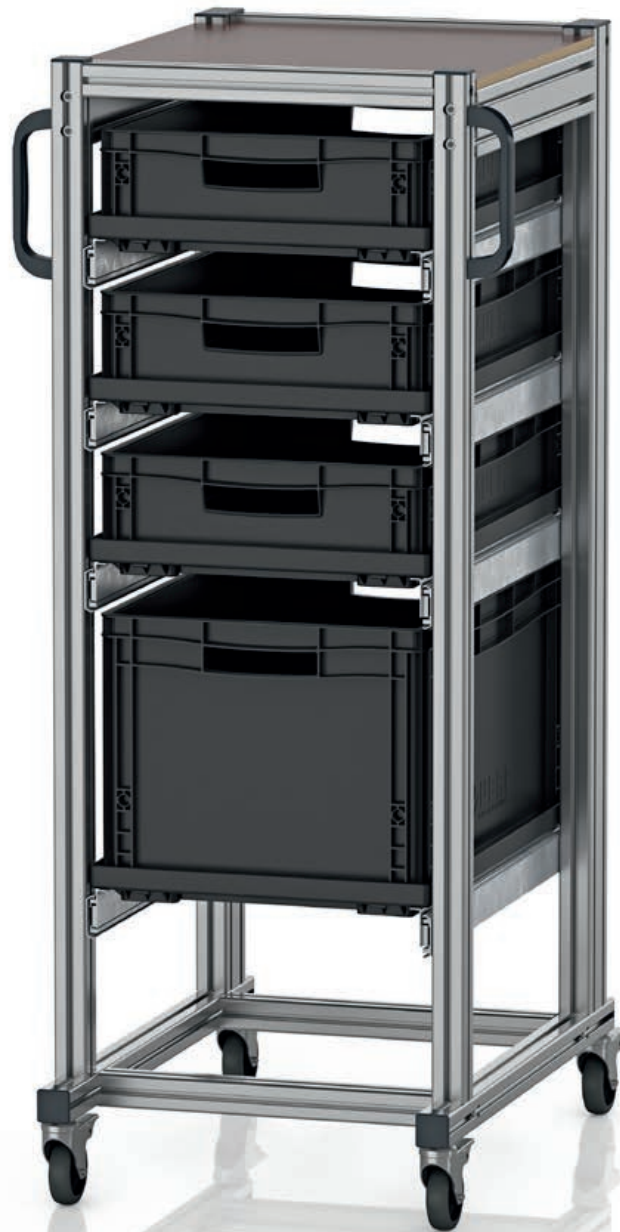

6



Tidiness on the move

AUER Packaging's ESD system trolley for Euro containers is the ideal solution if the ESD-sensitive contents are frequently required at different work stations. All its parts, including the rollers, are manufactured using electrically conductive plastic and are consequently securely protected from electrostatic charges.

- Stable aluminium profile construction
- High load-bearing capacity
- Lockable easy running rollers
- Easy to move, even when loaded



ESD SYSTEM TROLLEYS FOR EURO CONTAINERS 60 x 40 cm HEIGHT 134 cm

RAL 9017

	Outer dimensions L x W x H (cm)	Article No.	Design	Equipment	Price for single unit
1	72 x50 x135	ESD SE 134 64 U.2	one-sided	5 x full extension	€842.59
2	72 x50 x135	ESD SE 134 6475.2	one-sided	6 x full extension, 6 x ESD EG 64/75 HG	€946.53
3	72 x50 x135	ESD SE 134 6412.2	one-sided	5 x full extension, 5 x ESD EG 64/12 HG	€889.98
4	72 x50 x135	ESD SE 134 6417.2	one-sided	4 x full extension, 4 x ESD EG 64/17 HG	€830.66
5	72 x50 x135	ESD SE 134 6422.2	one-sided	3 x full extension, 3 x ESD EG 64/22 HG	€766.17
6	72 x50 x135	ESD SE 134 6432.2	one-sided	4 x full extension, 3 x ESD EG 64/12 HG, 1 x ESD EG 64/32 HG	€829.03
7	72 x50 x135	ESD SE 134 6442.2	one-sided	2 x full extension, 2 x ESD EG 64/42 HG	€709.18



ESD SYSTEM TROLLEYS FOR EURO CONTAINERS 60 x 40 cm HEIGHT 200 cm

AVAILABLE UP FROM 1 PIECE
no minimum purchase order.



Mobile organisation in XL-format

The ESD system trolley for Euro containers made by AUER Packaging is the ideal solution when the ESD-sensitive content of an especially large number of Euro containers is continuously required at different work stations. All parts including the casters are made of conductive plastic and are thus protected against electrostatic charging.

- Stable aluminium profile
- High load-bearing capacity
- Extra high model
- Lockable easy running rollers
- Easy to move, even when loaded



ESD SYSTEM TROLLEYS FOR EURO CONTAINERS 60 x 40 cm HEIGHT 200 cm

RAL 9017

	Outer dimensions L x W x H (cm)	Article No.	Design	Equipment	Price for single unit
1	72 x50 x201	ESD SE 200 64 U.2	one-sided	6 x full extension	€933.98
2	72 x50 x201	ESD SE 200 6475.2	one-sided	12 x full extension, 12 x ESD EG 64/75 HG	€1,368.00
3	72 x50 x201	ESD SE 200 6412.2	one-sided	9 x full extension, 9 x ESD EG 64/12 HG	€1,189.00
4	72 x50 x201	ESD SE 200 6417.2	one-sided	7 x full extension, 7 x ESD EG 64/17 HG	€1,068.00
5	72 x50 x201	ESD SE 200 6422.2	one-sided	6 x full extension, 6 x ESD EG 64/22 HG	€1,007.00
6	72 x50 x201	ESD SE 200 643212.2	one-sided	7 x full extension, 2 x ESD EG 64/32 HG, 5 x ESD EG 64/12 HG	€1,067.00
7	72 x50 x201	ESD SE 200 644232.2	one-sided	4 x full extension, 2 x ESD EG 64/42 HG, 2 x ESD EG 64/32 HG	€885.45



ESD SYSTEM TROLLEYS FOR EURO CONTAINERS 80 x 60 cm HEIGHT 134 cm

AVAILABLE UP FROM 1 PIECE
no minimum purchase order.



Mobile organisation with huge capacity

The ESD system trolley for Euro containers made by AUER Packaging is the ideal solution when the ESD-sensitive content of large-volume Euro containers is continuously required at different work stations. All parts including the casters are made of conductive plastic and are thus protected against electrostatic charging.

- Stable aluminium profile
- High load-bearing capacity
- For containers with basic dimensions of 80 x 60 cm
- Lockable easy running rollers
- Easy to move, even when loaded



ESD SYSTEM TROLLEYS FOR EURO CONTAINERS 80 x 60 cm HEIGHT 134 cm

RAL 9017

	Outer dimensions L x W x H (cm)	Article No.	Design	Equipment	Price for single unit
1	70 x 94 x 135	ESD SE 134 86 U	one-sided	5 x full extension	€1,036.00
2	70 x 94 x 135	ESD SE 134 8612	one-sided	5 x full extension, 5 x ESD EG 86/12 HG	€1,152.00
3	70 x 94 x 135	ESD SE 134 8622	one-sided	3 x full extension, 3 x ESD EG 86/22 HG	€972.01
4	70 x 94 x 135	ESD SE 134 8642	one-sided	2 x full extension, 2 x ESD EG 86/42 HG	€892.04
5	70 x 94 x 135	ESD SE 134 863212	one-sided	4 x full extension, 1 x ESD EG 86/32 HG, 3 x ESD EG 86/12 HG	€1,064.00



ESD SYSTEM TROLLEYS FOR EURO CONTAINERS 80 x 60 cm HEIGHT 200 cm

AVAILABLE UP FROM 1 PIECE
no minimum purchase order.



Mobile organisation - XXL in terms of height and capacity

The ESD system trolley for Euro containers made by AUER Packaging is the ideal solution when the ESD-sensitive content of very many large-volume Euro containers is continuously required at different work stations. All parts including the casters are made of conductive plastic and are thus protected against electrostatic charging.

- Stable aluminium profile
- High load-bearing capacity
- Maximum usable volume
- Lockable easy running rollers
- Easy to move, even when loaded



ESD SYSTEM TROLLEYS FOR EURO CONTAINERS 80 x 60 cm HEIGHT 200 cm

RAL 9017

	Outer dimensions L x W x H (cm)	Article No.	Design	Equipment	Price for single unit
1	70 x94 x200	ESD SE 200 86 U	one-sided	6 x full extension	€1,143.00
2	70 x94 x200	ESD SE 200 8612	one-sided	9 x full extension, 9 x ESD EG 86/12 HG	€1,567.00
3	70 x94 x200	ESD SE 200 8622	one-sided	6 x full extension, 6 x ESD EG 86/22 HG	€1,304.00
4	70 x94 x200	ESD SE 200 863212	one-sided	7 x full extension, 5 x ESD 86/12 HG, 2 x ESD 86/32 HG	€1,390.00
5	70 x94 x200	ESD SE 200 864232	one-sided	4 x full extension, 2 x ESD EG 86/42 HG, 2 x ESD EG 86/32 HG	€1,131.00



ESD FOLDABLE BOXES

AVAILABLE UP FROM 1 PIECE
no minimum purchase order.



Anti-static in action

In a few simple steps, the volume of AUER Packaging's ESD foldable box can be reduced by up to 82%. What is more, the box is particularly light, very stable and stackable. The electrically conductive material reliably protects the electronic components from electrical charges.

- Electrically conductive material
- Secure, quick folding
- Up to 82% reduction in volume
- Sealable with lid



ESD FOLDABLE BOXES WITHOUT LID

RAL 9017

Outer dimensions L x W x H (cm)	Article No.	Price for single unit	Units on pallet	Unit price on pallet
40 x 30 x 22.0	ESD FB 43/22	€17.65	280	€13.58
40 x 30 x 27.0	ESD FB 43/27	€19.29	220	€14.84
40 x 30 x 32.0	ESD FB 43/32	€20.40	220	€15.69
60 x 40 x 22.0	ESD FB 64/22	€23.33	140	€17.95
60 x 40 x 27.0	ESD FB 64/27	€24.95	140	€19.19
60 x 40 x 32.0	ESD FB 64/32	€26.51	140	€20.39
60 x 40 x 42.0	ESD FB 64/42	€32.15	110	€24.73
80 x 60 x 44.5	ESD FB 86/445	€59.45	40	€45.73



ESD FOLDABLE BOXES WITH LID

RAL 9017

Outer dimensions L x W x H (cm)	Article No.	Price for single unit	Units on pallet	Unit price on pallet
40 x 30 x 22.0	ESD FBD 43/22	€20.99	280	€16.14
40 x 30 x 27.0	ESD FBD 43/27	€22.62	220	€17.40
40 x 30 x 32.0	ESD FBD 43/32	€23.73	220	€18.25
60 x 40 x 22.0	ESD FBD 64/22	€28.85	140	€22.19
60 x 40 x 27.0	ESD FBD 64/27	€30.47	140	€23.44
60 x 40 x 32.0	ESD FBD 64/32	€32.03	140	€24.64
60 x 40 x 42.0	ESD FBD 64/42	€37.27	110	€28.67
80 x 60 x 44.5	ESD FBD 86/445	€69.73	40	€53.64



ESD HINGED LID FOR FOLDABLE BOXES

RAL 9017

Suitable for basic dimension	Article No.	Price for single unit	Units on pallet	Unit price on pallet
40 x 30	ESD FB DE 43	€3.27	800	€2.52
60 x 40	ESD FB DE 64	€5.46	440	€4.20
80 x 60	ESD FB DE 86	€9.59	75	€7.38



SEAL

RAL 9017

Article No.	Tensile load-bea- ring capacity	Price for single unit	Units on pallet	Unit price on pallet
PB	approx. 20 N	€0.28	125000	€0.21



OUR TIP: SEALING WITH PLUG-IN SEALS

Plug-in seals are used to seal transport containers. If the container has been opened, the seal at the predetermined break point is destroyed, which is an indication that something about the contents might have changed. Plug-in seals are suitable for reusable containers, IBC containers and folding boxes.

ESD-R-KLT BOXES

AVAILABLE UP FROM 1 PIECE
no minimum purchase order.



Fit seamlessly into each other

AUER Packaging's ESD R-KLT container is perfectly adapted to automated production processes and is suitable for use at various stages of production. Sensitive electronic components can be stored and transported without any problems thanks to the electrically conductive plastic.

- With ribbed base
- Built-in lid slits
- With adhesive surfaces for barcode
- Quiet running on conveyors

ESD-R-KLT BOXES WITH RIBBED BASE

RAL 9017

Outer dimensions L x W x H (cm)	Article No.	Base design	Price for single unit	Units on pallet	Unit price on pallet
30 x 20 x 15	ESD R-KLT 3215	Smooth, closed	€3.69	320	€2.84
40 x 30 x 15	ESD R-KLT 4315	Sturdy base ribbing, closed	€7.94	160	€6.10
40 x 30 x 28	ESD R-KLT 4329	Sturdy base ribbing, closed	€11.45	80	€8.80
60 x 40 x 15	ESD R-KLT 6415	Sturdy base ribbing, closed	€13.09	80	€10.07
60 x 40 x 28	ESD R-KLT 6429	Sturdy base ribbing, closed	€18.66	40	€14.35



***) only for orders placed via the online shop. Dispatch only on working days, provided the goods are in stock. Information regarding availability and current dispatch times can be found in the online shop.

ESD-RL-KLT BOXES

AVAILABLE UP FROM 1 PIECE
no minimum purchase order.

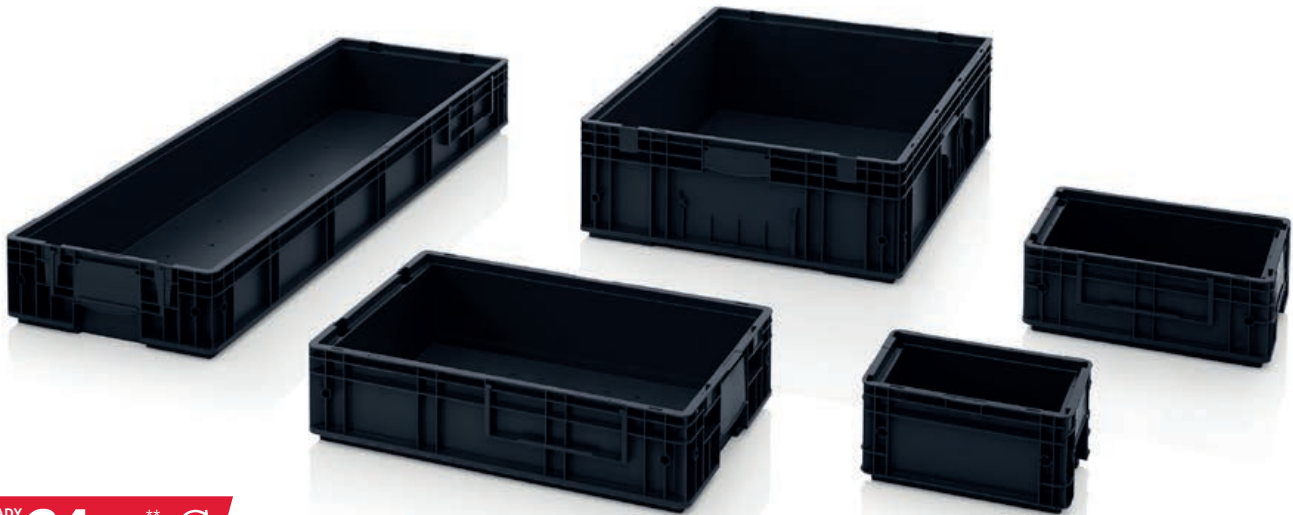

READY FOR DISPATCH within **24 hours** **



Material flow conforming to the VDA standard

AUER Packaging's ESD RL-KLT box features a smooth underside and it incorporates drainage holes according to VDS classification directive BG 4.3 (except for the RL-KLT 3147). The electrically conductive material reliably protects the electronic components from static charges.

- Smooth base and inner walls
- Built-in lid slits
- With adhesive surfaces for barcode
- With drain holes

ESD-RL-KLT BOXES WITH SMOOTH BASE AND DRAIN HOLES

RAL 9017

Outer dimensions L x W x H (cm)	Article No.	Base design	Price for single unit	Units on pallet	Unit price on pallet
30 x 20 x 14.7	ESD RL-KLT 3147	Smooth, closed	€3.69	320	€2.84
40 x 30 x 14.7	ESD RL-KLT 4147	Smooth, closed with drainage holes	€6.89	160	€5.30
40 x 30 x 28.0	ESD RL-KLT 4280	Smooth, closed with drainage holes	€10.70	80	€8.23
60 x 40 x 14.7	ESD RL-KLT 6147	Smooth, closed with drainage holes	€11.29	80	€8.69
60 x 40 x 28.0	ESD RL-KLT 6280	Smooth, closed with drainage holes	€16.77	40	€12.90



ESD MAXI KLT CONTAINERS

RAL 9017

Outer dimensions L x W x H (cm)	Article No.	Base design	Price for single unit	Units on pallet	Unit price on pallet
80 x 60 x 22.0	ESD RL-KLT 8210 g	Smooth, closed with drainage holes	€26.45	20	€20.35
120 x 40 x 14.7	ESD KLT 12415	Reinforced, closed	€29.49	32	€22.69



***) only for orders placed via the online shop. Dispatch only on working days, provided the goods are in stock. Information regarding availability and current dispatch times can be found in the online shop.

FOLDABLE ESD-KLT BOXES

AVAILABLE UP FROM 1 PIECE
no minimum purchase order.

READY FOR DISPATCH within **24** hours **



Anti-static space savers

AUER Packaging's ESD KLT container is really multi-talented: it combines the advantages of the small load carrier series with the space-saving properties of foldable boxes, and it is also adapted to the specific requirements of sensitive electronic components. What is more, the volume of the box can be reduced by up to 70%.

- With ribbed base
- Secure, quick folding
- Built-in lid slits
- With adhesive surfaces for barcode

FOLDABLE ESD-KLT BOXES

RAL 9017

Outer dimensions L x W x H (cm)	Article No.	Base design	Price for single unit	Units on pallet	Unit price on pallet
60 x 40 x 28	ESD F-KLT 6410	Sturdy base ribbing, closed	€34.96	135	€26.89



***) only for orders placed via the online shop. Dispatch only on working days, provided the goods are in stock. Information regarding availability and current dispatch times can be found in the online shop.

FOLDABLE ESD BIG BOXES WITH 4 OPENING FLAPS



AVAILABLE UP FROM 1 PIECE
no minimum purchase order.

READY FOR DISPATCH **24** hours**
within



Anti-static in large format

Ease and convenience of handling is provided by AUER Packaging's collapsible big box with 4 opening flaps: four flaps in the side walls provide quick and convenient access to the contents. When not in use or being returned empty, the side walls can be folded inwards to save space.

- Electrically conductive material
- Comfortable loading and unloading
- With optional label holder

FOLDABLE ESD BIG BOXES WITH 4 OPENING FLAPS

RAL 9017

Outer dimensions L x W x H (cm)	Article No.	Design	Price for single unit	Units per stack on truck	Unit price on truck
120 x 80 x 100	ESD KLK 1208	4 feet	€601.30	5	€462.54
120 x 80 x 100	ESD KLK 1208K	3 skids	€622.79	5	€479.07
120 x 80 x 110	ESD KLK 1208R	4 wheels	€659.80	5	€507.54
120 x 100 x 100	ESD KLK 1210	4 feet	€618.68	5	€475.91
120 x 100 x 100	ESD KLK 1210K	3 skids	€640.15	5	€492.42
120 x 100 x 110	ESD KLK 1210R	4 wheels	€677.18	5	€520.91



***) only for orders placed via the online shop. Dispatch only on working days, provided the goods are in stock.
Information regarding availability and current dispatch times can be found in the online shop.

ESD LIGHTWEIGHT PALLETS

AVAILABLE UP FROM 1 PIECE
no minimum purchase order.

READY FOR DISPATCH within **24** hours**

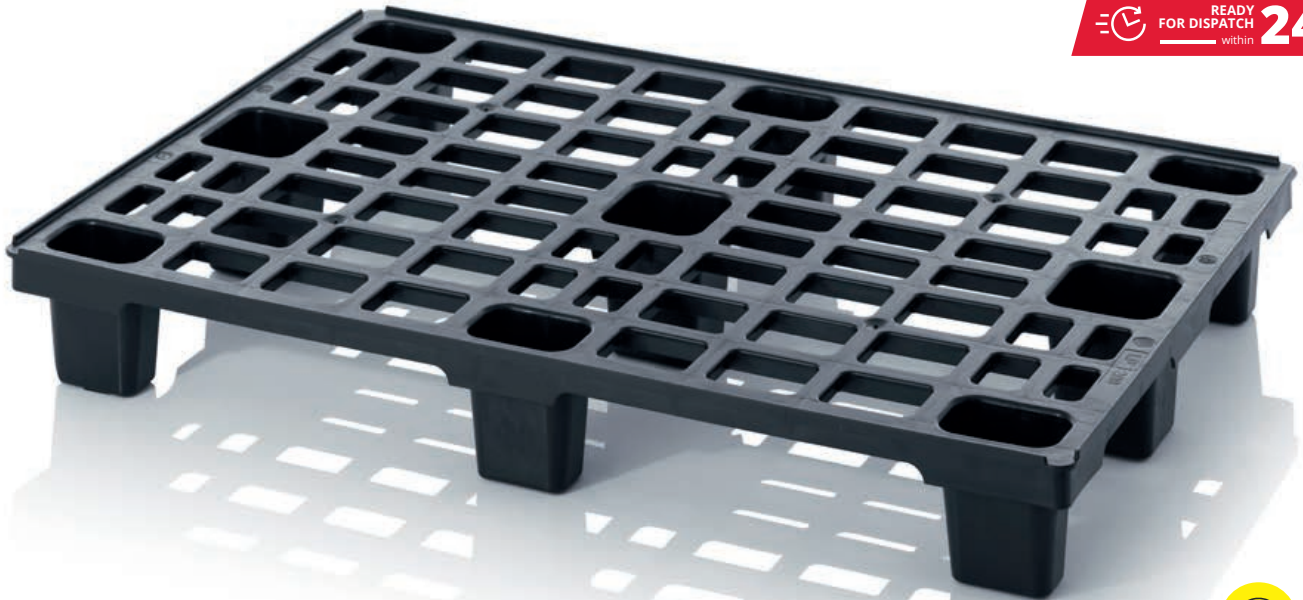

Anti-static lightweights

The outstanding property of AUER Packaging's ESD lightweight pallet is its especially low empty weight. It nevertheless has an impressive load-bearing capacity and can therefore be used for worldwide exports. The electrically conductive ESD version is particularly suited for the storage and transportation of electronic components.

- Electrically conductive material
- Can be stacked inside each other to save space
- Low empty weight
- Suitable for worldwide exports

ESD LIGHTWEIGHT PALLETS WITH RETAINING EDGE

RAL 9017

Outer dimensions L x W (cm)	Article No.	Design	Price for single unit	Units per stack on truck	Unit price on truck
80 x 60	ESD LP 86	with 6 feet	€24.86	100	€19.13
120 x 80	ESD LP 1208	with 9 feet	€30.57	50	€23.52
120 x 80	ESD LP 1208K	with 3 skids	€41.36	15	€31.81
120 x 100	ESD LP 1210	with 9 feet	€39.57	50	€30.44
120 x 100	ESD LP 1210K	with 3 skids	€51.97	15	€39.98



ESD LIGHTWEIGHT PALLETS WITHOUT RETAINING EDGE

RAL 9017

Outer dimensions L x W (cm)	Article No.	Design	Price for single unit	Units per stack on truck	Unit price on truck
80 x 60	ESD LP 86 OS	with 6 feet	€31.83	100	€24.48
120 x 80	ESD LP 1208 OS	with 9 feet	€37.53	50	€28.87
120 x 80	ESD LP 1208K OS	with 3 skids	€45.42	15	€34.94
120 x 100	ESD LP 1210 OS	with 9 feet	€43.99	50	€33.84
120 x 100	ESD LP 1210K OS	with 3 skids	€51.97	15	€39.98



***) only for orders placed via the online shop. Dispatch only on working days, provided the goods are in stock. Information regarding availability and current dispatch times can be found in the online shop.

ESD PALLETS WITH SOLID COVER

AVAILABLE UP FROM 1 PIECE
no minimum purchase order.

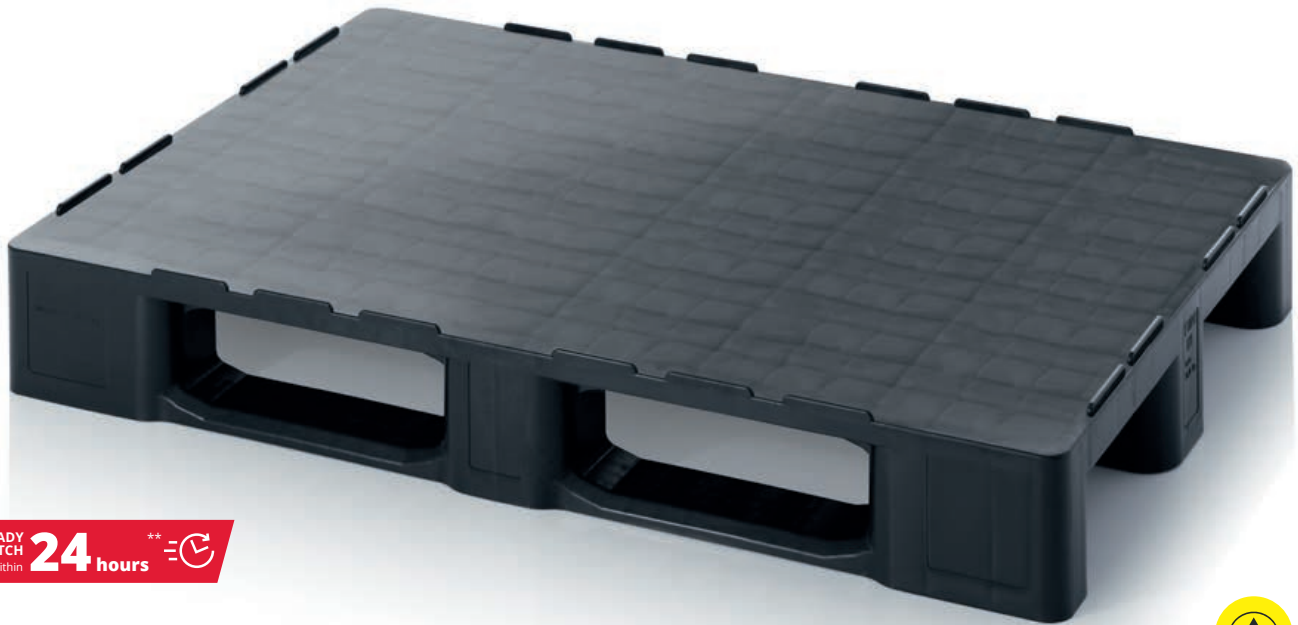

Anti-static cleanroom marvels

AUER Packaging's ESD pallet with solid base protects your goods during storage and transportation; its smooth surface also makes it particularly easy to clean. Sensitive electronic goods are protected from charges thanks to the special electrically conductive material.

- Electrically conductive material
- High load-bearing capacity
- Optional steel rod reinforcement
- Suitable for high-bay racking
- Also available without retaining edge

ESD PALLETS WITH SOLID COVER WITH RETAINING EDGE

RAL 9017

Outer dimensions L x W (cm)	Article No.	Design	Price for single unit	Units per stack on truck	Unit price on truck
120 x 80	ESD H 1208	Without steel tube, with 3 skids	€90.63	15	€69.72
120 x 80	ESD HD 1208	With 2 steel tubes, with 3 skids	€106.13	15	€81.64
120 x 100	ESD H 1210	Without steel tube, with 3 skids	€107.59	15	€82.76
120 x 100	ESD HD 1210	With 2 steel tubes, with 3 skids	€123.09	15	€94.68
120 x 100	ESD H 12105	Without steel tube, with 5 skids	€115.15	15	€88.58
120 x 100	ESD HD 12105	With 2 steel tubes, with 5 skids	€135.56	15	€104.28



ESD PALLETS WITH SOLID COVER WITHOUT RETAINING EDGE

RAL 9017

Outer dimensions L x W (cm)	Article No.	Design	Price for single unit	Units per stack on truck	Unit price on truck
120 x 80	ESD H 1208 OS	Without steel tube, with 3 skids	€90.63	15	€69.72
120 x 80	ESD HD 1208 OS	With 2 steel tubes, with 3 skids	€106.13	15	€81.64
120 x 100	ESD H 1210 OS	Without steel tube, with 3 skids	€107.59	15	€82.76
120 x 100	ESD HD 1210 OS	With 2 steel tubes, with 3 skids	€123.09	15	€94.68
120 x 100	ESD H 12105 OS	Without steel tube, with 5 skids	€115.15	15	€88.58
120 x 100	ESD HD 12105 OS	With 2 steel tubes, with 5 skids	€130.65	15	€100.50



***) only for orders placed via the online shop. Dispatch only on working days, provided the goods are in stock. Information regarding availability and current dispatch times can be found in the online shop.

ESD INSERTABLE BINS FOR ESD EURO CONTAINERS

AVAILABLE UP FROM 1 PIECE
no minimum purchase order.

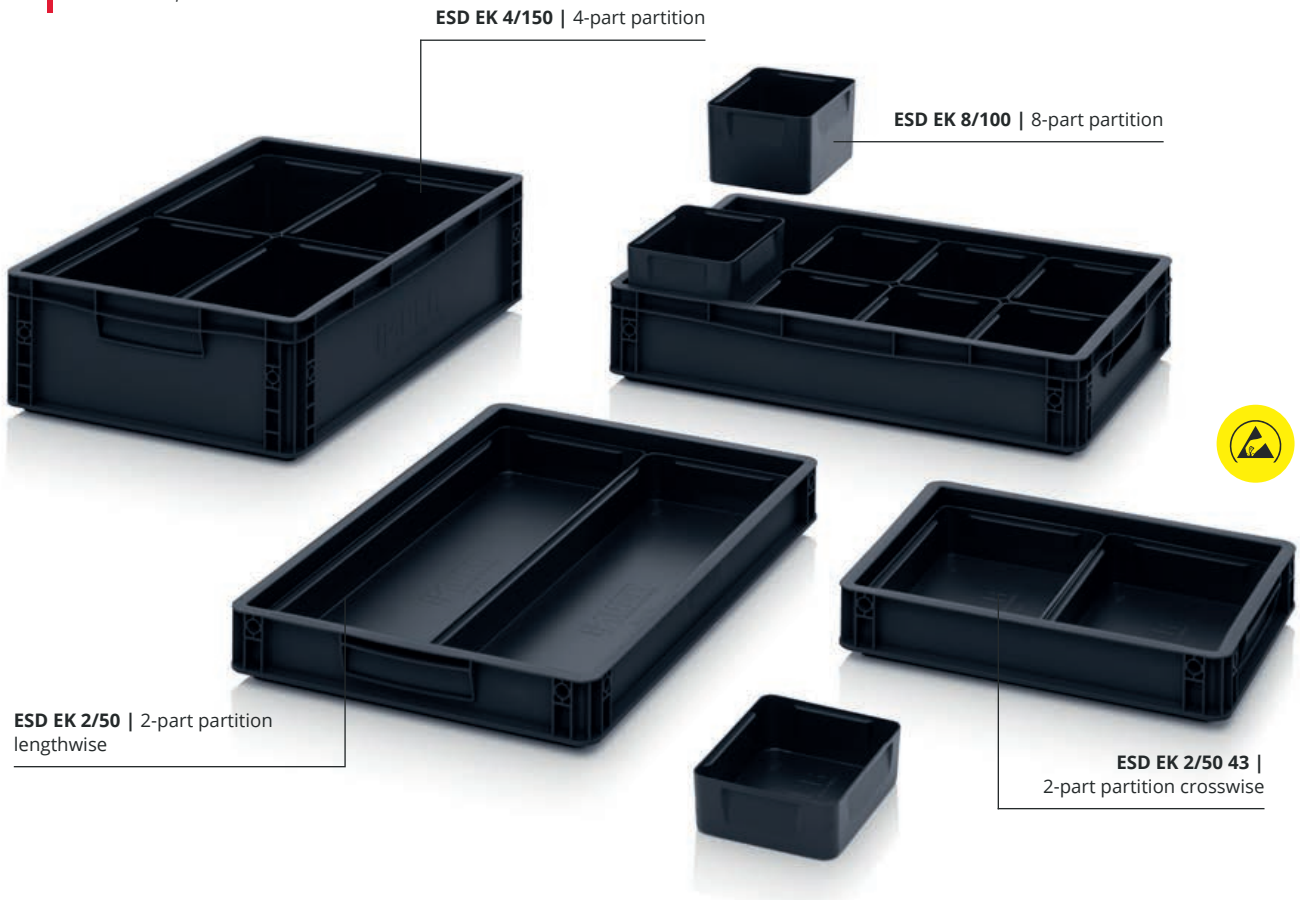

Flexibly subdivided

AUER Packaging's ESD insertable bin is the ideal solution for flexibly subdividing ESD Euro containers. It can first be filled and pre-picked with varying loads of initial parts and then combined with other insertable bins in the Euro container. A Euro container with basic dimensions of 60x40 cm can hold up to eight insertable bins.

- Electrically conductive material
- Grip rim for easy handling
- Stackable due to reinforced rim
- Variety of possible loading options



ESD INSERTABLE BINS FOR 40 x 30 cm ESD EURO CONTAINERS

RAL 9017

	Outer dimensions L x W x H (cm)	Height (cm)	Article No.	Division	Price for single unit	Units on pallet	Unit price on pallet
1	26.6 x 18.4 x 5	5	ESD EK 2/50 43	2 crosswise compartments	€5.09	1012	€3.91
2	26.6 x 18.4 x 10	10	ESD EK 2/100 43	2 crosswise compartments	€7.06	440	€5.43
3	26.6 x 18.4 x 15	15	ESD EK 2/150 43	2 crosswise compartments	€6.69	300	€5.15



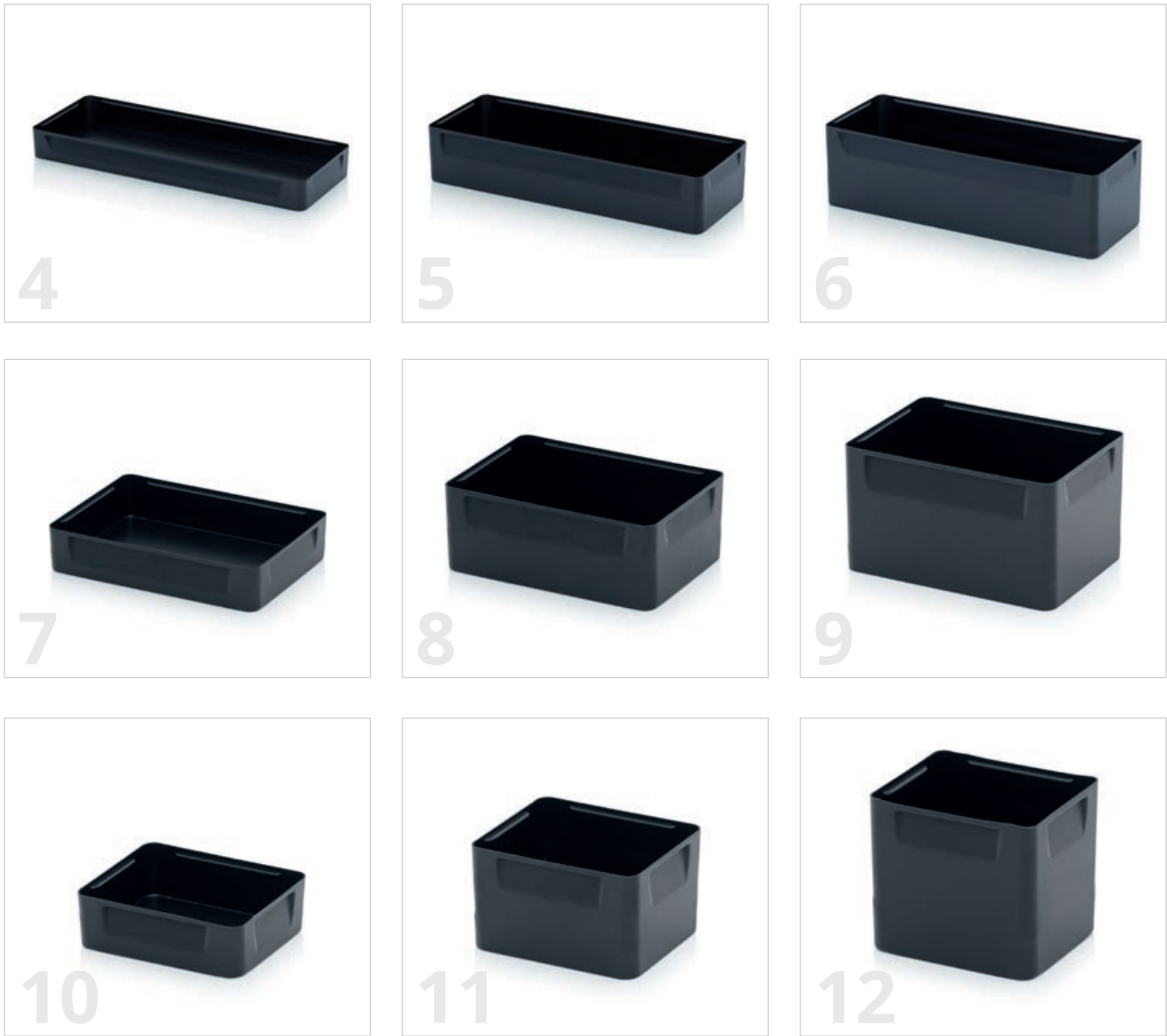

ESD INSERTABLE BINS FOR 60 x 40 cm ESD EURO CONTAINERS

RAL 9017

	Outer dimensions L x W x H (cm)	Height (cm)	Article No.	Division	Price for single unit	Units on pallet	Unit price on pallet
4	56 x 18.3 x 5	5	ESD EK 2/50	2-part partition length	€6.70	440	€5.16
5	56 x 18.3 x 10	10	ESD EK 2/100	2-part partition length	€11.15	220	€8.57
6	56 x 18.3 x 15	15	ESD EK 2/150	2-part partition length	€13.57	150	€10.44
7	28.2 x 18.3 x 5	5	ESD EK 4/50	4th division	€5.40	968	€4.16
8	28.2 x 18.3 x 10	10	ESD EK 4/100	4th division	€7.06	440	€5.43
9	28.2 x 18.3 x 15	15	ESD EK 4/150	4th division	€8.80	300	€6.77
10	18.3 x 14.1 x 5	5	ESD EK 8/50	8th division	€3.77	1800	€2.90
11	18.3 x 14.1 x 10	10	ESD EK 8/100	8th division	€4.65	880	€3.57
12	18.3 x 14.1 x 15	15	ESD EK 8/150	8th division	€5.45	630	€4.19



OUR TIP: STACK INSERT BOXES

Our insert boxes are stackable, providing an overview and order in the Euro container. Insert boxes can be combined flexibly in different heights.

Our customer service will gladly assist you: info@auer-packaging.com

CUSTOMISED ESD INSERTS FOR ESD EURO CONTAINERS

AVAILABLE UP FROM 1 PIECE
no minimum purchase order.



Practical compartments

AUER Packaging's ESD transverse divider is the perfect solution if you want to subdivide your ESD Euro containers crosswise: a narrow insert on each of its long sides holds the dividers securely in place. Please note that the transverse dividers can only be configured in the online shop.

- Very stable due to narrow inserts
- Electrically conductive material
- Custom-made
- Matched to EURO dimensions

OUR TIP: CONFIGURE INSERTS ONLINE

In our online shop, you can individually configure special compartments as well as longitudinal and cross dividers for Euro containers. Simply choose the basic size of the container, the height of the insert and the desired divider.

Order online now: www.auer-packaging.com

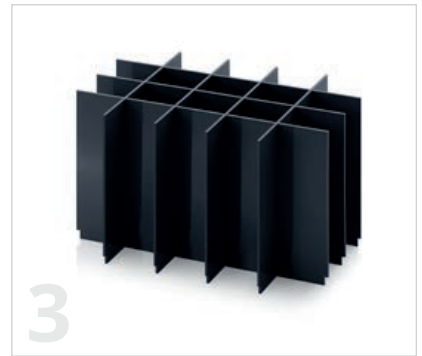
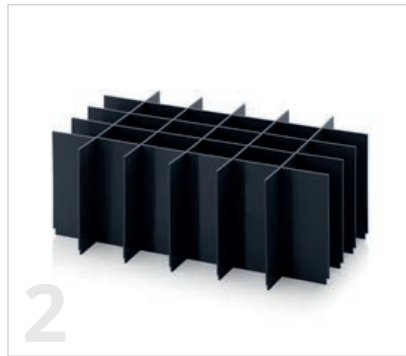

ESD SPECIAL COMPARTMENTS FOR ESD EURO CONTAINERS

RAL 9017

Article No.	Design	Height	Length divider	Cross divider	Unit price
1	ESD EG SGF 4375 Set for base dimension 40 x 30 cm	5 - 30 cm	1 - 10	1 - 10	starting at €8.40
2	ESD EG SGF 6475 Set for base dimension 60 x 40 cm	5 - 40 cm	1 - 10	1 - 10	starting at €10.00
3	ESD EG SGF 8612 Set for base dimension 80 x 60 cm	5 - 60 cm	1 - 10	1 - 10	starting at €17.65



ESD TRANSVERSE DIVIDERS FOR ESD EURO CONTAINERS

RAL 9017

Article No.	Design	Height	Cross divider	Unit price
4	ESD QT GEF 43 Set for base dimension 40 x 30 cm	5 - 30 cm	1 - 20	starting at €42.13
5	ESD QT GEF 64 Set for base dimension 60 x 40 cm	5 - 40 cm	1 - 20	starting at €43.74
6	ESD QT GEF 86 Set for base dimension 80 x 60 cm	5 - 60 cm	1 - 20	starting at €53.38



ESD LONGITUDINAL DIVIDERS FOR ESD EURO CONTAINERS

RAL 9017

Article No.	Design	Height	Length divider	Unit price
7	ESD LT GEF 43 Set for base dimension 40 x 30 cm	5 - 30 cm	1 - 20	starting at €43.74
8	ESD LT GEF 64 Set for base dimension 60 x 40 cm	5 - 40 cm	1 - 20	starting at €48.44
9	ESD LT GEF 86 Set for base dimension 80 x 60 cm	5 - 60 cm	1 - 20	starting at €62.90



ACCESSORIES ESD PRODUCTS



1 | ESD HINGE LIDS FOR EURO CONTAINERS

RAL 9017

Suitable for basic dimension	Article No.	Price for single unit	Units on pallet	Unit price on pallet
20 x 15	ESD SD 215	€4.08	3200	€3.14
30 x 20	ESD SD 32	€3.80	1600	€2.93
40 x 30	ESD SD 43	€4.02	800	€3.09
60 x 40	ESD SD 64	€6.34	600	€4.88
80 x 60	ESD SD 86	€14.57	300	€11.21



2 | ESD ELECTRICALLY CONDUCTIVE LID FOR EURO CONTAINERS

RAL 9017

Suitable for basic dimension	Article No.	Price for single unit	Units on pallet	Unit price on pallet
20 x15	ESD DE 215	€1.86	8640	€1.43
30 x20	ESD DE 32	€1.96	4140	€1.51
40 x30	ESD DE 43	€6.77	800	€5.21
60 x40	ESD DE 64	€9.59	600	€7.38
80 x60	ESD DE 86	€20.51	50	€15.77



3 | ESD LIDS FOR KLT CONTAINERS

RAL 9017

Suitable for basic dimension	Article No.	Price for single unit	Units on pallet	Unit price on pallet
30 x20	ESD KLT-D 35	€1.14	1600	€0.88
40 x30	ESD KLT-D 45	€2.15	880	€1.65
60 x40	ESD KLT-D 65	€3.80	600	€2.92



4 | ESD PLACE-ON LIDS FOR BIG BOXES

RAL 9017

Suitable for basic dimension	Article No.	Price for single unit	Units per stack on truck	Unit price on truck
120 x80	ESD DE 1208 BB	€72.08	50	€55.45
120 x100	ESD DE 1210 BB	€77.77	50	€59.82



5 | ESD PALLET PLACE-ON LIDS MULTI-PURPOSE

RAL 9017

Suitable for basic dimension	Article No.	Price for single unit	Units per stack on truck	Unit price on truck
120 x 80	ESD A 1208	€77.40	100	€59.54
120 x 100	ESD A 1210	€86.31	100	€66.39



6 | ESD PALLET PLACE-ON LIDS KLT FOR KLT CONTAINERS

RAL 9017

Suitable for basic dimension	Article No.	Price for single unit	Units per stack on truck	Unit price on truck
120 x 80	ESD A 1208-1	€32.74	50	€25.19
120 x 100	ESD A 1210-1	€39.63	50	€30.49



7 | ESD SPACERS CLASSIC

RAL 9017

Outer dimensions L x W (cm)	Article No.	Price for single unit	Units per pallet	Unit price on pallet
36.5 x 26.5	ESD ZP43	€14.53	500	€11.18
57.0 x 36.5	ESD ZP64	€27.98	500	€21.52
76.0 x 56.0	ESD ZP86	€55.72	500	€42.86

8 | ESD TRANSPORT TROLLEYS

RAL 9017

Outer dimensions L x W (cm)	Article No.	Design Castors	Price for single unit	Units on pallet	Unit price on pallet
62 x 42	ESD RO 64.4	4 steering castors	€38.31	84	€29.47
62 x 42	ESD RO 64.4 FE	2 steering castors, 2 steering castors with wheel stop	€42.45	84	€32.65
82 x 62	ESD RO 86.4 HD	4 steering castors	€84.96	26	€65.36



9 | ADHESIVE LABEL "ESD"

Dimensions W x H (cm)	Article No.	Unit price
25 x 30	AK ESD	€0.28



PRINTING

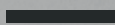

No problem!

PRINTING, 1-COLOUR

Product	Printing	1-50 per unit	51-100 per unit	starting at 101 per unit
Container size up to 80 x 60 cm*	1-sided	€4.18	€4.04	€3.90
Container size over 80 x 60 cm	1-sided	€9.81	€9.48	€9.16
Container size up to 80 x 60 cm*	2-sided	€5.57	€5.38	€5.20
Container size over 80 x 60 cm	2-sided	€13.08	€12.64	€12.21
Container size up to 80 x 60 cm*	3-sided	€8.35	€8.07	€7.80
Container size over 80 x 60 cm	3-sided	€19.62	€18.97	€18.31
Container size up to 80 x 60 cm*	4-sided	€11.14	€10.76	€10.39
Container size over 80 x 60 cm	4-sided	€26.16	€25.29	€24.42

PRINTING, 2-COLOUR

Product	Printing	1-50 per unit	51-100 per unit	starting at 101 per unit
Container size up to 80 x 60 cm*	1-sided	€8.35	€8.07	€7.80
Container size over 80 x 60 cm	1-sided	€19.62	€18.97	€18.31
Container size up to 80 x 60 cm*	2-sided	€11.14	€10.76	€10.39
Container size over 80 x 60 cm	2-sided	€26.16	€25.29	€24.42
Container size up to 80 x 60 cm*	3-sided	€16.70	€16.15	€15.59
Container size over 80 x 60 cm	3-sided	€39.24	€37.93	€36.62
Container size up to 80 x 60 cm*	4-sided	€22.27	€21.53	€20.79
Container size over 80 x 60 cm	4-sided	€52.32	€50.58	€48.83

PRINTING, 3-COLOUR

Product	Printing	1-50 per unit	51-100 per unit	starting at 101 per unit
Container size up to 80 x 60 cm*	1-sided	€12.53	€12.11	€11.69
Container size over 80 x 60 cm	1-sided	€29.43	€28.45	€27.47
Container size up to 80 x 60 cm*	2-sided	€16.70	€16.15	€15.59
Container size over 80 x 60 cm	2-sided	€39.24	€37.93	€36.62
Container size up to 80 x 60 cm*	3-sided	€25.06	€24.22	€23.39
Container size over 80 x 60 cm	3-sided	€58.86	€56.90	€54.94
Container size up to 80 x 60 cm*	4-sided	€33.41	€32.29	€31.18
Container size over 80 x 60 cm	4-sided	€78.48	€75.86	€73.25

PRINTING, 4-COLOUR

Product	Printing	1-50 per unit	51-100 per unit	starting at 101 per unit
Container size up to 80 x 60 cm*	1-sided	€16.70	€16.15	€15.59
Container size over 80 x 60 cm	1-sided	€39.24	€37.93	€36.62
Container size up to 80 x 60 cm*	2-sided	€22.27	€21.53	€20.79
Container size over 80 x 60 cm	2-sided	€52.32	€50.58	€48.83
Container size up to 80 x 60 cm*	3-sided	€33.41	€32.29	€31.18
Container size over 80 x 60 cm	3-sided	€78.48	€75.86	€73.25
Container size up to 80 x 60 cm*	4-sided	€44.54	€43.06	€41.57
Container size over 80 x 60 cm	4-sided	€104.64	€101.15	€97.66

*) except big boxes 80 x 60 cm



SPECIAL COLOURS

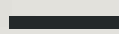

Your product in your colour



RAL 1003
SIGNAL YELLOW

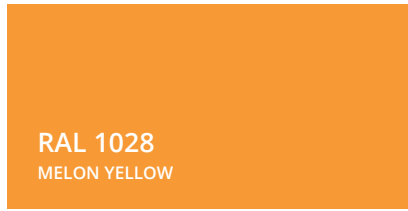

RAL 1028
MELON YELLOW



RAL 2002
VERMILION



RAL 2010
SIGNAL ORANGE



RAL 3020
TRAFFIC RED



RAL 4006
TRAFFIC PURPLE

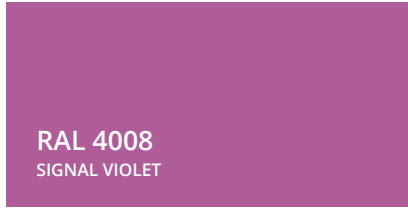

RAL 4008
SIGNAL VIOLET



RAL 5003
SAPPHIRE BLUE

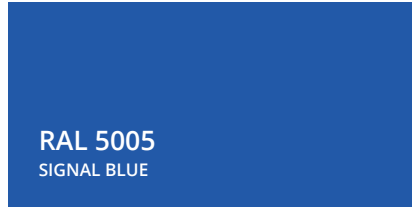

RAL 5005
SIGNAL BLUE

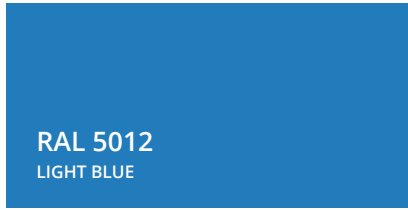

RAL 5012
LIGHT BLUE



RAL 5015
SKY BLUE



RAL 6003
OLIVE GREEN



RAL 6005
MOSS GREEN

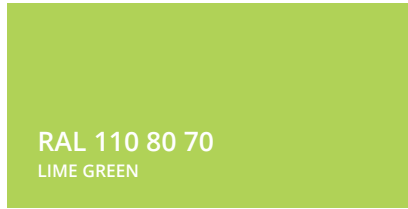

RAL 110 80 70
LIME GREEN



RAL 6011
RESEDA GREEN

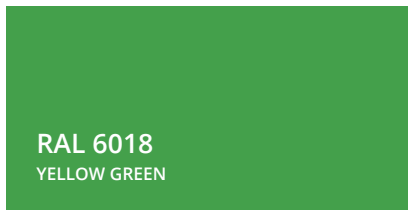

RAL 6018
YELLOW GREEN

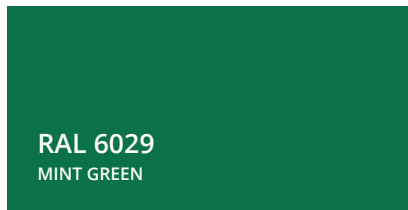

RAL 6029
MINT GREEN

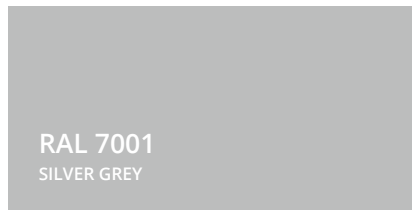

RAL 7001
SILVER GREY

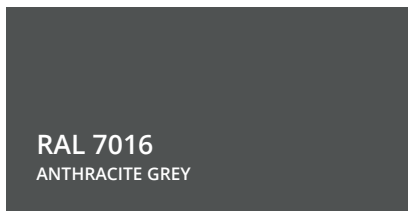

RAL 7016
ANTHRACITE GREY

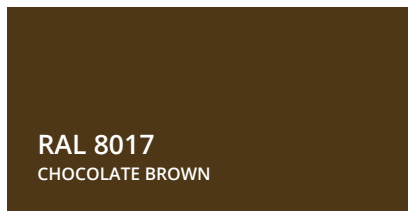

RAL 8017
CHOCOLATE BROWN

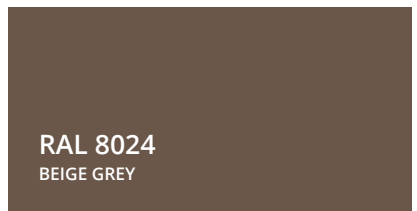

RAL 8024
BEIGE GREY



RAL 9017
TRAFFIC BLACK

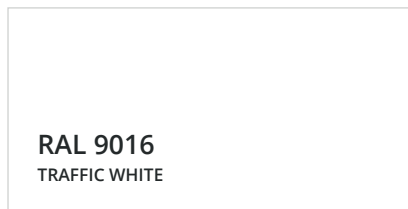

RAL 9016
TRAFFIC WHITE

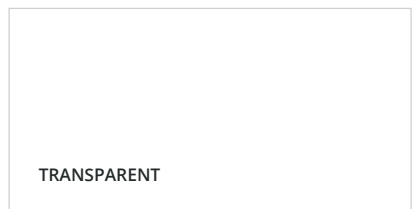

TRANSPARENT



TRADE FAIR DATES

Experience AUER live



You will find all trade fair dates currently being planned on our website:

www.auer-packaging.com/fairs



REFERENCES

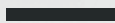

Quality provides confidence



Mercedes-Benz



Audi



KONICA MINOLTA





AUER

QUALITY
MADE IN GERMANY



- | | |
|---|--|
|  AUER Packaging Austria
www.auer-packaging.at |  AUER Packaging Luxembourg
www.auer-packaging.lu |
|  AUER Packaging België
www.auer-packaging.be |  AUER Packaging Mexico
www.auer-packaging.mx |
|  AUER Packaging Bulgaria
www.auer-packaging.bg |  AUER Packaging Nederland
www.auer-packaging.nl |
|  AUER Packaging Swiss GmbH
www.auer-packaging.ch |  AUER Packaging Norge
www.auer-packaging.no |
|  AUER Packaging Češko
www.auer-packaging.cz |  AUER Packaging Polska
www.auer-packaging.pl |
|  AUER Packaging Deutschland
www.auer-packaging.de |  AUER Packaging Portugal
www.auer-packaging.pt |
|  AUER Packaging Danmark
www.auer-packaging.dk |  AUER Packaging România
www.auer-packaging.ro |
|  AUER Packaging España
www.auer-packaging.es |  AUER Packaging Россия
www.auer-packaging.ru |
|  AUER Packaging Suomi
www.auer-packaging.fi |  AUER Packaging Sverige
www.auer-packaging.se |
|  AUER Packaging France
www.auer-packaging.fr |  AUER Packaging Slovenija
www.auer-packaging.si |
|  AUER Packaging Greece
www.auer-packaging.gr |  AUER Packaging Slovensko
www.auer-packaging.sk |
|  AUER Packaging Magyarország
www.auer-packaging.hu |  AUER Packaging Türkiye
www.auer-packaging.com.tr |
|  AUER Packaging Ireland
www.auer-packaging.ie |  AUER Packaging U.K.
www.auer-packaging.co.uk |
|  AUER Packaging Italia
www.auer-packaging.it | |

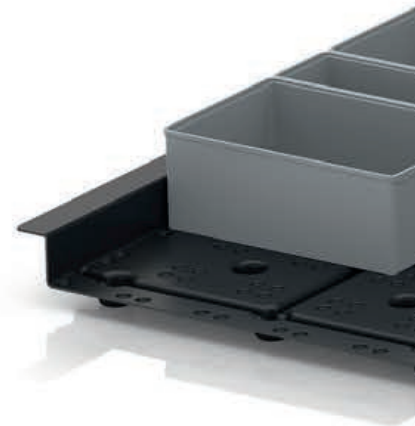

AUER GmbH
Technologiepark

Am Kroit 25/27
D-83123 Amerang

Tel. +49 8075 91333-840
Fax +49 8075 91333-841

info@auer-packaging.com
www.auer-packaging.com